

Off-Highway Motorcycle & ATV Trails Guidelines for Design, Construction, Maintenance and User Satisfaction

**2nd Edition
By Joe Wernex**

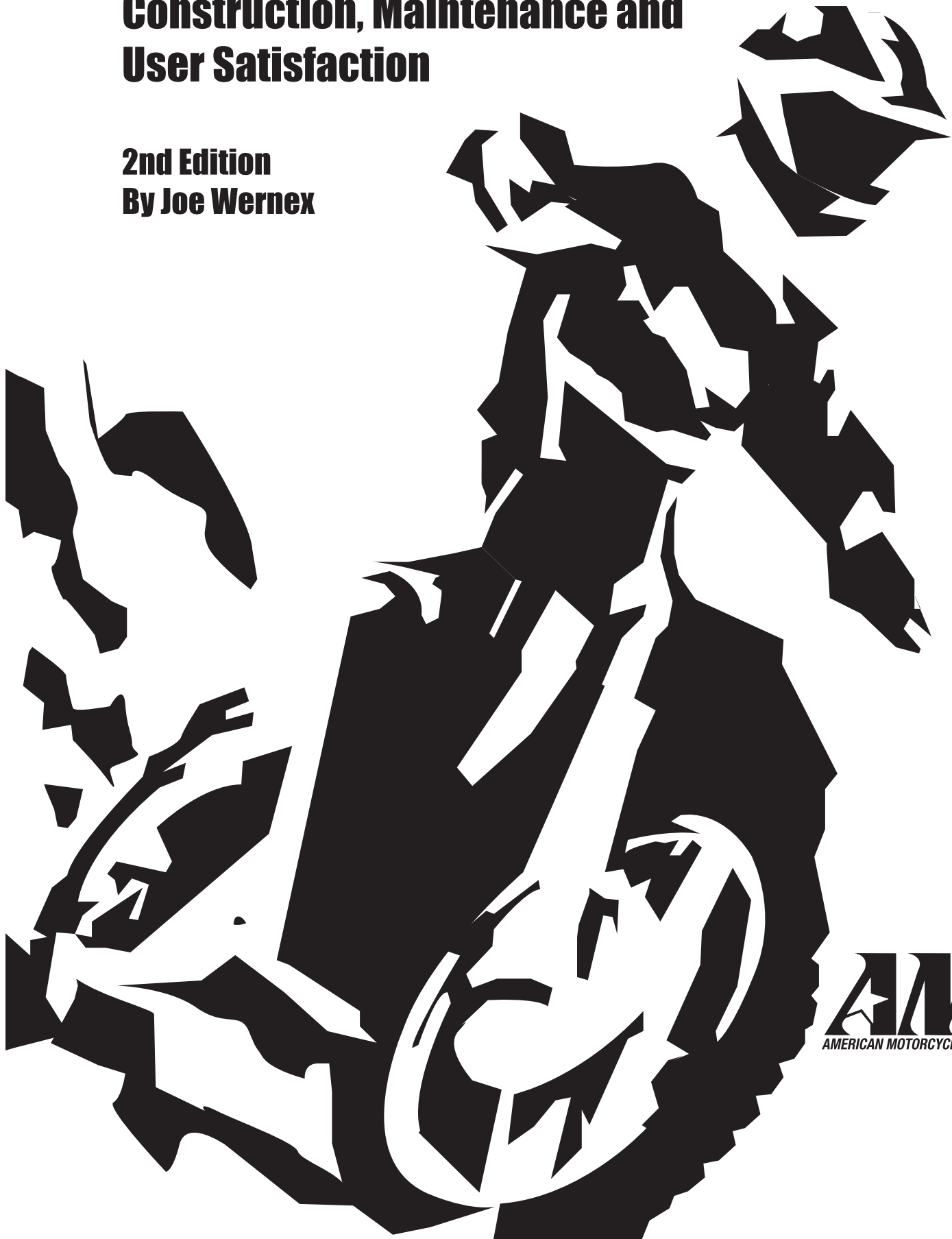

AMA
AMERICAN MOTORCYCLIST ASSOCIATION

OFF-HIGHWAY MOTORCYCLE AND ATV TRAILS:

Guidelines For Design, Construction, Maintenance And User Satisfaction

Second Edition

By Joe Wernex

Additional contributions by Michael Dolfay, Master Performer, Trail Recreation, Wenatchee National Forest, Cam Lockwood, OHV Recreation Coordinator, Angelis National Forest, Dick Duford, Deschutes National Forest, The Recreation Staff of the Talledaga National Forest, Jim Williams, Director of OHV Planning, Motorcycle Industry Council, and Eric Lundquist, Legislative Affairs Specialist, American Motorcyclist Association.

Photographs by Roy Janson, Joe Wernex, Jim Cooper, Dick Duford and the Motorcycle Industry Council. Illustrations by Marc Dobner and the Motorcycle Industry Council. Second Edition edited by Eric Lundquist.

First Edition published as: **A GUIDE TO OFF-ROAD MOTORCYCLE TRAIL DESIGN AND CONSTRUCTION** by Joe Wernex, American Motorcyclist Association (1984).

This publication is intended to assist in the design, construction and management of off-highway motorcycle (OHM) and all-terrain vehicle (ATV) recreation trails. The American Motorcyclist Association and the contributing authors assume no responsibility for the application of this information.

Publication was made possible partly through a generous grant from the Motorcycle Industry Council and the Specialty Vehicle Institute of America.

Copyright 1994, American Motorcyclist Association, All rights reserved. Printed in U.S.A. No part of this publication may be reproduced or transmitted in any form without the written permission of the publisher.

Published by the
American Motorcyclist Association
13515 Yarmouth Drive
Pickerington, Ohio 43147



INTRODUCTION TO THE SECOND EDITION

After twenty-six years of involvement with trailbike recreation I welcome the opportunity once again to work with the American Motorcyclist Association in the development of this second edition.

It has indeed been rewarding to observe the determined effort put forth in many agencies and in many states to provide for and manage trailbike recreation. One of the great bright spots in the country has been the excellent program administered by the Idaho Department of Parks and Recreation. At the same time it has been disappointing to find that some prejudiced few have discriminated against those who enjoy motorized trail recreation.

Something that has not changed is that nothing government agencies can do goes further toward managing trailbike use than developing adequate mileage of high quality trails.

Firsthand experience has made it abundantly clear that no amount of restriction or enforcement can begin to provide the environmental protection achieved through provision of adequate facilities and rider education. When quality trails are built, riders use them. When riders use properly constructed trails, environmental impacts can be designed for, monitored and controlled. The single most important key is adequate mileage of high quality, competently designed trail.

Let me restate that trailbike and ATV enthusiasts require considerable mileage for a quality outing. It is wise to plan multiple trail systems, each with adequate mileage to provide several full days of riding without having to retrace part of the previous day's route. The lack of adequate trail mileage for OHV recreation is one of the most serious problems facing public lands managers.

Disturbing though it is, one sometimes has the misfortune to learn of instances where trailbike recreationists have been the victims of mismanagement or bias. While it is not my intention to address fully the prejudice at times directed at motorized enthusiasts, it is necessary to touch on the all too frequent strategy of closing trails rather than managing them equitably and competently. To be sure, there are times when temporary closure of a trail to ALL types of recreation travel is a reasonable option to consider.

However, in the case of trailbikes or all terrain vehicles, unwarranted trail closure has caused a self-fulfilling prophecy of trail damage that leads to trail damage. It goes something like this: First minor damage is found on a few trails. The damage is the result of foot,

horse and trailbike use on improperly designed or poorly maintained trails. Trails are then closed to "prevent resource damage." Interestingly, the trails are closed only to trailbikes and ATVs or in some cases trailbikes, ATVs and horses.

After the closure there are fewer trails available to support a growing population of motorized recreationists, and overuse begins to take its toll. Managers again close more trails and the self-fulfilling prophecy has come full circle. The burden has once again fallen on one or two groups of outdoor recreationists. There is no substitute for adequate mileage of well maintained, competently designed trails, at least not for the conscientious land manager.

The text that follows was written to aid planners in the development of trailbike trails in a mountainous forest environment. However, others have indicated that the techniques described have broad application and are useful in developing trails in many environments and for ATV recreation as well.

My goal was to provide a tool that would help public lands managers meet their responsibility to provide high quality outdoor recreation opportunities for trailbike enthusiasts ... on an equitable basis with other trail users.

The state of the art in motorized trail planning should be in constant flux. Constantly test new ideas. Implement the best ones. Planners should first acquire an understanding of the recreation and its participants then develop an analytic approach to developing and managing trails and facilities. With notable exceptions this has happened all too seldom. There needs to be a program to provide the training planners need to competently locate, design, construct and manage motorized trails. There is need for serious research to solve problems such as "dusting out" and tread stabilization. The moral and ethical questions surrounding the problems of bias and even bigotry against motorized recreation need to be openly addressed and impartially resolved.

Unfortunately, training beyond the introductory stage is generally not available; sound professional research does not appear to be on the horizon and questions of moral and ethical conduct in dealing with the rights of motorized recreationists is carefully avoided. These are the hard questions and difficult issues. It is my hope that some of those who read this handbook will rise to these challenges.

J. J. Wernex November, 1993

CHAPTER ONE

INVENTORY THE UNIT

Before a logical trail system plan can be developed, the planner must know what is happening on the land base and predict with reasonable accuracy what is going to happen in the future. The **inventory** is a collection of information about the land base that will assist in making decisions about trail development and management. It should be of a general nature, with investigation done to obtain site-specific requirements. Most information will be more useful if it is plotted on a map of suitable scale to encompass the entire unit, usually 1/2 inch = 1 mile (or larger).

The following will help the planner determine what is needed for a workable inventory.

Much useful information can be found on existing maps. Start with the transportation system. Most existing roads and trails should already be on your map; if not, locate them on the ground and get them mapped. You are encouraged to become proficient in the use of aerial photographs. When viewed in stereopairs, they are very useful for finding existing trails, roads and other features. In areas that already support trailbike and ATV use, riders are an excellent source of information. Take the time to establish contact with those who use the area and request their help. It would be foolish not to involve riders in the planning process.

Roads should be classified according to their "standard." At the very least this will require information about gradient, width, alignment, surface, location, type and volume of traffic, and other factors that may affect suitability for use by recreation traffic. Roads provide the access to trailheads and campgrounds.

Get out on the ground and conduct a thorough survey of trail conditions. Trails should be classified by trail type. Take notes as to which trails would be best for motorcycles and those that will accommodate ATVs. It may be convenient to break the various trails into segments to make it easier to catalog information. A trailbike with a resetable odometer is excellent for measuring and segmenting trails. Unimproved trails will seldom be homogeneous throughout their length; that is, a single trail will often have segments in two or more of the three trail categories (**Easiest, More Difficult, Most Difficult**).

TAKE CLEAR DESCRIPTIVE NOTES.

It will be worthwhile to give names **and** numbers to trails to aid in their identification. Develop a logical numbering system that allows for expansion. Names are important to riders and will aid in communication. Numbers are easier to use on an inventory or map.

During the condition survey, look for problems that need to be corrected. This includes tread erosion, excessive grade, unstable soil, poor drainage and improper location.

Soil conditions are extremely important, planners must study the relationship between soil type, grade and trail use. Determine the ability of the various soils to withstand trail use. Soil maps may be helpful, but should be supplemented with firsthand knowledge of each specific site.

Micro sites in some types of soil call for use of special



The survey stake marks a road location that will significantly degrade the quality of this trail.

tread protection techniques to enable them to withstand trail traffic. (Special tread protection techniques will be covered in another section.) The trail condition survey should uncover areas requiring the use of special techniques. Determine their extent and estimate the cost.

Identify sensitive areas that require special consideration or avoidance. Examples include areas that contain resorts, summer homes, archaeological sites and endangered plants and animals. One must locate such problem areas and determine how they will be managed before the trail system plan is developed. An acoustic impact prediction method has been developed by the U.S. Forest Service that is very useful in predicting and managing the acoustic impact of trailbikes and ATVs (see Chapter 8). The use of this technique should be considered for identifying noise-sensitive sites.

Trail planning **must** be integrated with other land management activities. It is essential to obtain information about these activities and relate it to the inventory map. For example, plot the locations of future roads, timber sales, mining activities, leases, reforestation, and the like. Failure to exercise integrated planning can result in disastrous waste. A \$50,000 trail can easily be destroyed by the construction of five miles of road.

Camping is an integral part of motorized recreation. Include both existing and potential campsites in the inventory.



Look for features that will enhance the trailriding experience.

Finally, **the single most important aspect of the inventory is to identify and locate features that enhance the trail experience.** There are endless factors that make up a high-quality trail experience. It varies by individual rider, but if one were to pick a single most important item it would probably be variety. Typical of the features the knowledgeable trail planner looks for are: waterfalls, lakes, streams, cliffs, changing timber and vegetation type, meadows, vistas, talus slopes, hot springs and even large rocks.

In areas where large elevation differentials result in snowmelt extending over a significant time, determine how snowmelt will affect trail use. Look for places where large snow drifts can block trails until late in the season

and avoid them. Examine and learn to understand the relationship between aspect, elevation and snowmelt. Snow takes longer to melt off of north and east facing slopes and higher elevations.

Last, try to figure out what you may have forgotten. Before the trail system plan is started, the planner must see what is being dealt with. To a large extent, developing an inventory is preliminary reconnaissance.

A Note on Global Positioning System Technology

A number of federal public lands agencies are using the **Global Positioning System** (GPS), developed by the military, to accurately map the locations of roads and trails. Hardware and software are available to local



Mapping and inventory work using GPS systems is currently being performed by both agency personnel as well as volunteers. Note the GPS antenna mounted on the rider's helmet.

management units to directly plot road and trail locations for input to the Geographical Information System (GIS) being developed nationally.

GPS uses a series of 22 satellites positioned 22,000 miles above the earth. A portable antenna is used to locate the point on earth relative to four of the satellites. Currently employed systems are accurate to plus or minus 15 feet. The operator, with the antenna attached to his or her helmet rides the road or trail and collects point position data at one second intervals. This point data is translated into a line. The line data is transferred to the GIS and becomes an accurate map.

CHAPTER TWO PLANNING THE TRAIL SYSTEM

Once the inventory is complete the next step is to assemble the trail system plan. The plan is a blueprint for the facilities to be constructed. It will directly affect the quality of the recreation experience, and the ease (or difficulty) of management.

Successful planning for trailbike and ATV recreation requires firsthand knowledge. Therefore, we begin our discussion with some fundamental characteristics of motorized recreation trails and riders.

Trailbike and ATV enthusiasts are extremely diverse in the skills they possess and their preferences for type and length of trail. Individuals seldom ride alone, nor should they for safety's sake. In many, if not most, areas of the country they normally camp together in groups of three to five families. This fact presents the planner with the need to develop trails of various lengths and difficulty for riders with distinctly different levels of skill.

To help the planner understand the characteristics of the different kinds of trails needed to adequately provide

for the recreation, a system has been developed to rate trails according to their relative difficulty and the appropriate level of skill. The rating system has been used to provide information on maps and signs.

The system suggested in the first edition of this book rated trails as **Easiest**, **More Difficult** and **Most Difficult**. This did not always produce consistent ratings.

The dissimilarity in ratings appears to have been caused by trails being rated by individuals with limited knowledge of mountain trail riding and occasionally by expert level riders who failed to carefully and analytically apply the system or failed to give due consideration to all classes of riders. Accordingly, we have modified the system and added explanations and suggestions for its use.

This is a two-part system where trails are rated first according to their degree of difficulty, i.e. the level of skill necessary to safely ride and enjoy the experience and



Left, Most Difficult Trails should be expected to occasionally tax the skills of experienced riders. Above, an example of the type of rough surface riders will occasionally find on Most Difficult Trails.

second by a numeric rating to express the magnitude and frequency of risk or exposure inherent in use of the trail.

TRAIL DIFFICULTY RATING

- ◆ **EASIEST** trails are intended to be suitable for novice riders and those who don't have the skill or desire to ride more difficult trails. Easiest trails are often used as mainline or "trunk" trails that provide the principal access to a large trail system (to be classed as easiest, a trail must present a low level of exposure to the rider, i.e. 1 or 2).
- ◆ **MORE DIFFICULT** trails are intended for a majority of the enthusiast population. They require well-developed skills and trails that will at times prove challenging to the average rider.
- ◆ **MOST DIFFICULT** trails are intended for expert riders and dedicated enthusiasts. At times these trails will tax the skill of the dedicated enthusiast (This is the only class of trail where one would expect to encounter an exposure level greater than 4).

TRAIL EXPOSURE RATING

The **EXPOSURE RATING** provides an indication of the degree of risk posed to the rider by a trail or trail segment.

Exposure is rated on a scale of 1 through 5 with 1 indicating the least degree of exposure and 5 the

greatest. Rating for exposure is an exercise in carefully and objectively analyzing the risk posed to the rider. The rater must ask, "What is the probable consequence if a rider should fall or lose control?" The rider who falls on a trail located on moderate side slopes is in little danger, however to fall on a narrow trail located on bare, rocky 120 percent side slopes may place one at significant risk.

Care must be taken to factor in the difficulty rating because as the trail becomes more difficult to ride, it is harder to maintain control. The exposure rating takes into account both frequency and magnitude of conditions that increase or decrease risk.

ELEMENTS OF DIFFICULTY AND EXPOSURE

The frequency, magnitude and interrelationship of eight elements are evaluated to rate a trail for difficulty and exposure. The system relies on the experience, objectivity and judgment of the rater. Inexperienced or careless individuals are unlikely to produce consistent, reliable results. However, experienced, objective mountain trail riders can arrive at ratings that are consistent and meaningful to other trailbike or ATV enthusiasts.

- ◆ **ALIGNMENT** is the configuration of the trail in the horizontal plane. It consists of the curves, twists, corners and tangents the trail user must negotiate. The smaller the radius of the turns and the more frequent the curves, the more difficult the trail is to ride. Lest the wrong impression be given, it must be

ASPECT	EASIEST	MORE DIFFICULT	MOST DIFFICULT
Grade	Max. Sustained Pitch 8% Max. Pitch 15%	12% 30%	15% 50% (rare)
Minimum Clearing Width	Downhill side 2 feet Uphill side 3 feet Level each side 1.5 feet	1.5 feet 3 feet 1.5 feet each side	1.5 feet 2.5 feet 1.5 feet each side
(Wooded)	Downhill side 2 feet Uphill side 3 feet Level each side 2 feet	1.5 feet 3 feet 2 feet each side	1.5 feet 2.5 feet 1.5 feet each side
Clearing Height	9 feet	8 feet	8 feet
Tread Width	Minimum 18 inches* Maximum 30 inches	18 inches 24 inches	12 inches 24 inches
Tread Surface	Relatively smooth throughout, no rocks or roots protruding more than 3 inches. Avoid sand and loose materials.	Sections of relatively rough. Some loose sand, etc.	Relatively rough with short sections very rough. Long stretches of loose rock and sand, etc., desirable on occasion.

* Increase Tread width 6 to 20 inches on switchbacks or where side slopes exceed 50%. This chart is specific to trail bike trails. Trails for ATV use will have to be widened accordingly as indicated in this book. In any event, ATV trails will generally not include the slopes seen in the Most Difficult section.

Notice that the trail becomes less structured and more primitive as we progress from Easiest to Most Difficult.

noted here that twists and turns are **VERY DESIRABLE** features of trailbike and ATV trails.

Twists and turns do little to increase the difficulty or exposure until found in combination with steep grades, steep sideslopes, rough tread, etc.

- ◆ **GRADE** is the slope of the trail in the direction of travel, usually measured in percent. Moderate grade or slope has little effect on difficulty or exposure, however, steep grades can have a major effect. In the experience of the writer, the effect of grades under 15% is minor. Grades over 30% often make a major contribution to difficulty and exposure. Grade must be evaluated in its association with the other seven elements.
- ◆ **CLEARING** is the corridor from which vegetation or other obstacles are removed. Clearing becomes a factor when obstacles protrude into the travelway. Hidden rocks and stumps that can catch footpegs are easily identified hazards. Overgrown brush that obscures sight distance should be considered. Logs lying across the trail may make riding difficult or impossible. Although usually minor, there is some increase in risk in negotiating downed logs. Clearing is usually not a major factor in the degree of exposure, but may be so in the degree of difficulty. Downed logs across trails on steep side slopes may pose significant risk.
- ◆ **TREAD WIDTH** is the width of the traveled portion of the trail. On a hillside trail, it is that portion of the trail between the toe of the cut and the top of the fill. For trailbikes, a wider tread -- up to about three (3) feet -- provides for easier travel. Wider trails also afford the rider more opportunity to select a smoother, easier path of travel. The preferred width for trailbike trails is 18 to 24 inches with 6 to 12 inches of widening on sharp turns (switchbacks and climbing turns are a special case to be discussed later). Tread width does not become a major factor in the degree of difficulty and exposure until it is found in combination with other elements in their upper range.
- ◆ **TREAD SURFACE** is the physical condition of the tread. Smooth trails that provide good traction are the easiest to ride and present the least exposure. Rocks, roots, logs, mud or anything that provides a rough or slippery surface increases the difficulty and exposure.
- ◆ **OBSTACLES** are physical objects that impair travel. Logs, slides, large rocks, ledges and deep or swift water are some obstacles that increase difficulty and exposure.
- ◆ **SIDESLOPE** is the slope of the ground perpendicular to the direction of the trail. Sideslopes vary from flat to near vertical. As the sideslope becomes steeper, the perception of difficulty increases. Steepness of

sideslopes has a **MAJOR** effect on the degree of exposure. To understand this, contrast falling on a trail of 0% percent sideslope with falling on a trail where the sideslope is near vertical.

- ◆ **ISOLATION** is the relative distance or time from help or human contact. Isolation does not affect the degree of difficulty, however greater isolation does increase the degree of exposure. For a great many trailriding enthusiasts, isolation is an **EXTREMELY DESIRABLE** component of a quality trail ride.

The magnitude of the eight factors and the way they are combined are what determine the classification



Snow drifts that remain until late in the season limit trail use. This trail should have been developed in an alternate location.

of a particular trail. For example:

- ◆ A trail with gentle curves, wide, smooth tread (24 to 30 inches), 10 percent grade, side slopes of 10 to 35 percent, 10 miles from trailhead at farthest point, and no significant obstacles would be rated **EASIEST** and given an exposure rating of 1.
- ◆ A trail with frequent sharp curves, medium-wide tread (12 to 24 inches), partially rough surface, 30 miles from trailhead, grades up to 30 percent, side slopes up to 60 percent, and several moderate switchbacks would be rated **MORE DIFFICULT** and given an exposure rating of 2 or 3.
- ◆ A trail having sharp switchbacks on steep grades, constructed on steep side slopes of up to 100 percent, rough, loose tread surface with one or more 10-inch plus ledges would be ranked **MOST DIFFICULT** with an exposure rating of 4.

It is the **COMBINATION** of elements that produce the ultimate difficulty and exposure rating. Classification relies heavily on experience, careful observation and analysis to produce consistent ratings. Although this is not a precise system of rating, the goal of trail managers nationally should be to ultimately achieve a high level of uniformity.

Raters should be expert riders or have a very clear understanding of how riders perceive trail difficulty. A novice rider would tend to consider an Easiest trail as difficult and a More Difficult trail as impossible. This, of course, would render the classification system useless. Similarly, planners seem to rate trails as more difficult than they really are.



This well-designed stream crossing with its rock bed and sloped approaches reduces impacts while allowing for easy travel.

RIDE TO LEARN

There is no absolute rating scale for motorized recreation trails. However, to become a competent motorized trail planner, one must first become a competent rider. The best trail systems are planned by those who enjoy riding and have a "feel" for the recreation. The aspiring trailbike or ATV trail planner should ride a variety of trails. When trail systems fail to meet their objectives, the problem can often be traced back to the planner's failure to understand the trails, the sport and the participants.

In my experience, the best way to learn about the sport is to ride trails with active enthusiasts. Observe, listen and ask questions. Spend some time at their campfires and listen to riders of all skill levels -- their needs differ.

Time spent on the trail with OHV enthusiasts will yield valuable observations. First, most riders travel longer distances as they become more experienced. They venture farther from camp and tend to spend part of their day on trails that tax their skills. Novice riders usually prefer relatively short lengths of easy trail. Experienced

riders prefer trails of increasing difficulty and may ride over 100 miles in a single day.

Trail length and scenery are universal criterion by which riders measure the desirability of an area. Several years ago an informal study in the State of Washington found that the average off-highway motorcycle rider likes to ride 50-60 miles of trail per day. To the extent this information is applicable to other regions of the country one should attempt to provide 60 or more miles of trail in each trail system. It is **much more desirable** to develop trail systems in excess of 200 miles each. Realize that expert riders may want to travel over 100 miles per day. To satisfy the desire of a diverse rider population, distribute the trails in a 60 mile system as follows:

- ◆ Easiest, 10-15 miles;
- ◆ More Difficult, 30-50 miles; and
- ◆ Most Difficult, 10-15 miles.

A majority of trail mileage should be of the More Difficult type since this class is used by most riders.

Don't develop too much Easiest trail. This will result in unmet needs for a majority of the user population. It may also erode rider confidence in your ability to plan and manage.

ATV enthusiasts generally prefer to travel on wider and smoother trails. That doesn't mean that some won't use them on extremely steep, tight and rough trails. Unfortunately, when ATVs are used on narrow, tight, sidehill trails, serious damage can result. Because of their additional width the downhill wheel of an ATV rides on the edge of the fill and the uphill wheel rides on the cut slope. This causes the fill slope to slough off and causes part of the cut slope to slide into the trail tread. The result is a damaged trail prism.

As indicated earlier, the guidelines for motorcycles and ATVs are essentially the same except for tread width, clearing width, grades and -- most importantly -- the need to develop climbing turns, not switchbacks. It is difficult for ATV riders to use a conventionally constructed motorcycle trail. When planning, look for opportunities to use sections of old skid or access roads that have been retired from the transportation system. Such sections provide an opportunity for ATV riders when integrated into a planned system. However, remain cognizant that old access roads and skid trails **are not** what the motorcycle trail rider is looking for.

The **Loop Concept** is the cornerstone of motorized trail planning. With some notable exceptions, trail systems should always be designed to form multiple loops. Trails should not change class in the middle of a loop. A More Difficult trail may branch off an Easiest trail to form part of a larger loop, but the Easiest trail must form a complete loop of its own. Treat More Difficult and Most Difficult trails in the same manner. Never lead the

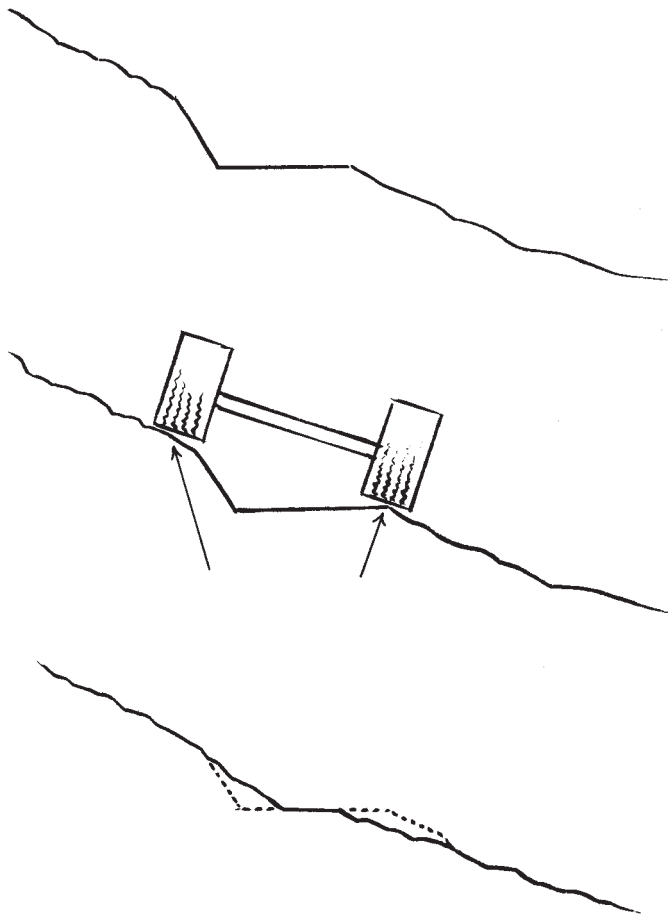

The top figure depicts an undisturbed, narrow (18"-24") motorcycle trail. If ATV use is permitted on this trail, the wheels, being too wide for the trail tread, ride on the cut bank or on top of the fill. After considerable use, the narrow trail is broken down and severely damaged.

rider into a situation where he or she must either turn back or continue on a route that may be beyond his or her ability.

There are exceptions to the singular use of loops. These include access routes to campgrounds and certain destination points such as mountain lakes or a spectacular waterfall.

CONTROL POINTS

Many planners use control points as a tool to help assemble the trail system plan and locate trails on the ground. In a broad sense a control point is anything that affects the location of the trail. In this context control points are things that tend to dictate the location of the trail. These might include terrain unsuitable for trail

construction such as cliffs, solid rock, unstable soil, property boundaries defining land not owned by the planning agency, highly desirable land features such as hot springs, scenic vistas, waterfalls and areas to be avoided such as noise sensitive sites. A good inventory will specify the location of many control points. While assembling the trail system plan, the planner must make frequent trips to the field to make refinements and discover site-specific controls that could alter trail locations or make them unfeasible.

Another kind of control point that needs to be taken into account is provided by aspect, elevation and climate. North and east facing slopes and higher elevations retain snowpack longer and soils may tend to stay more damp. Likewise, snow melts off south and west facing slopes earlier in the year and the soil dries sooner. The planner can, and should, use this knowledge to good advantage.

In an area that tends to be dry and where snow melts off early it may be beneficial to locate most trails on north slopes or at high elevations. This will help alleviate dusty trail conditions.

If the area normally has a heavy snowpack that remains until late in the year, or excess soil moisture is a problem, then one may opt to locate most trails on south and west facing slopes or at lower elevations. Identify and avoid locations where snowdrifts tend to remain until late in the year.

Good stream crossing locations will often act as control points. Streams must be forded, channeled through a culvert or bridged. The location chosen will affect construction costs, maintenance costs and the riding experience itself. Sites for fords require a rocky bed, stable stream banks and must not be too deep. The use of culverts on trails is limited by the size of pipe that can be conveniently transported to the site. Bridge locations must provide stable footing for abutments, adequate clearance for high water that will permit free passage of drift logs and adequate turning radius for traffic to enter and exit.

Most trailbike and ATV riders like to feel they have "been somewhere and covered some territory" in a day of riding. They generally prefer not to go over the same spot twice in one ride. To help convey the impression of having been somewhere it is advantageous to locate trail junctions some distance apart.

TRAILHEAD AND SUPPORT FACILITY DESIGN

Trailbikes and ATVs are normally hauled to the riding area and locations are needed to park and unload. Overnight camping goes hand-in-hand with mountain trail riding. It makes sense to plan for this activity in conjunction with trail development.

Studies conducted around the country have yielded a

number of interesting discoveries about motorized recreation enthusiasts and their camping preferences. Some of these findings have important management implications:

- ◆ Riders like to travel some distance (i.e., several miles) off of paved roads before stopping to camp.
- ◆ Many prefer to camp at sites with little or no development. At one popular riding area approximately 85 percent of riders pass up a developed campground in favor of undeveloped sites farther up the road.
- ◆ Riders who do use developed sites desire fire rings, clean rest rooms, picnic tables and potable water. Items such as power hookups and showers are often rejected as unnecessary.
- ◆ Riders do not object to having areas designated for parking or fire building. Other items to consider in developing campsites with a trailbike or ATV orientation:
 - ◆ Don't overdevelop or overstructure.
 - ◆ Do provide for group use.
 - ◆ Do provide a short (i.e., 1/2 mile) loop trail next to the camping area for youngsters.

- ◆ Always provide access to the trail system with a single trail from the campground.
- ◆ Don't make the access trail part of a loop.
- ◆ Discourage hillclimbing and bootleg trails by site selection, education, barriers and enforcement.
- ◆ Disperse trail use by strategically locating campsites and trailheads.
- ◆ Communicate with riders through signs at campground entrances and trailheads. For example, place a notice at the trailhead of the vehicle widths capable of using the trail in the agency's prescribed manner.

With the knowledge of trail riders' needs well in mind, and a thorough inventory in hand, the trail system plan should develop quite smoothly.

To begin, select campsite and trailhead locations. Establish these sites near terrain that lends itself to the development of Easiest trails. Use the information in the inventory to select the sites.

TRAIL CAPACITY

The concept of Trail Capacity may be used to express the physical ability of a trail to withstand use or the rate at

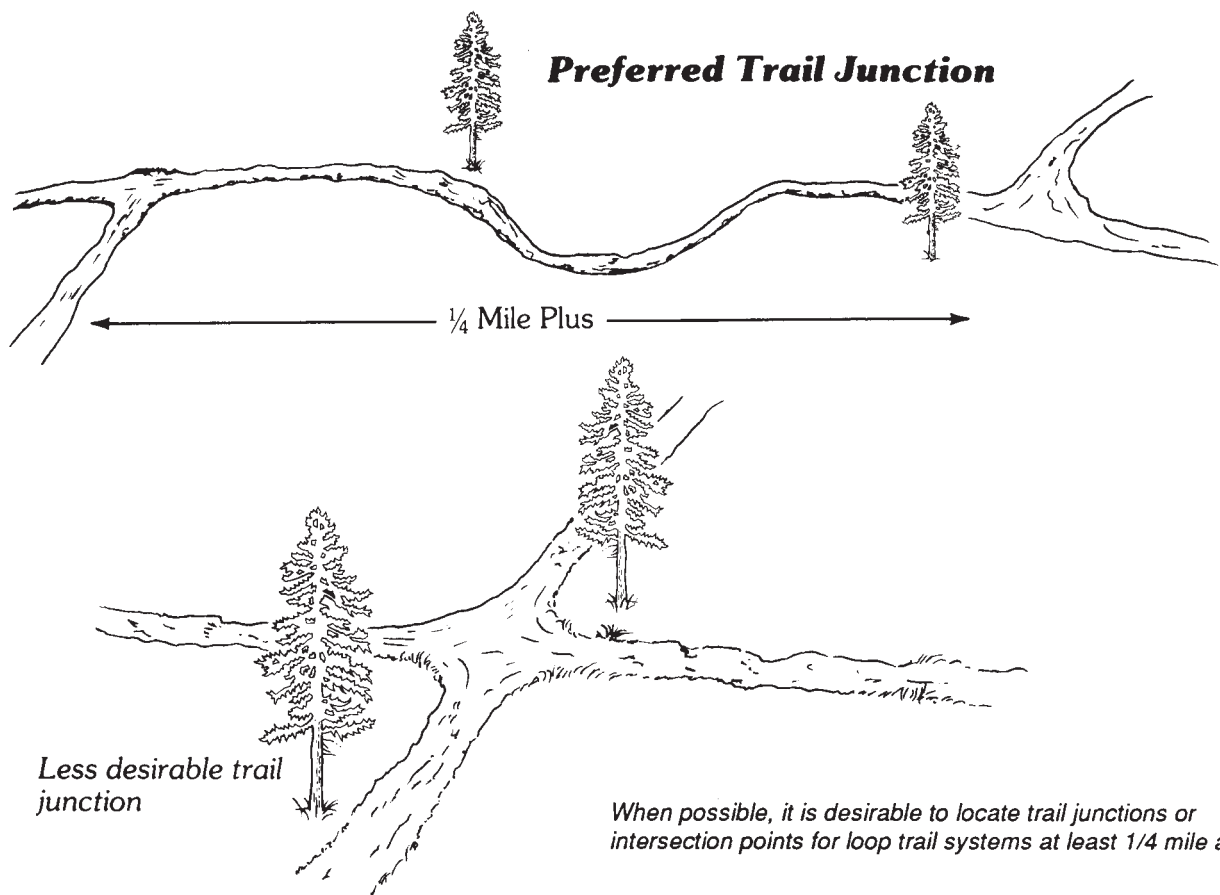

which a trail incurs wear that eventually results in the need for maintenance or replacement. For the purposes of this document, we will refer to this as the "physical capacity" of the trail. With careful observation, or better yet, actual measurement of relevant variables such as rainfall, soil type, season of use, grade and number of users it is possible to predict maintenance cycles and tread replacement needs.

"Trail Capacity" may also be used as an expression of the maximum number of recreationists that may use a given length of trail (usually one mile) in a given period of time (usually one day) and still meet user expectations for a particular type of wild land trail experience. We will refer to this as "user capacity." User capacity does not easily lend itself to quantification across a broad area of the country. User expectations vary greatly by geographic area and population densities. In the west, mountain trail riders seeking a primitive wildland experience may become utterly disgusted to encounter more than half a dozen other trail users in a full day of riding (usually 50 to 120 miles). At another place and time, these same riders may attend a social event such as a "poker run" and delight in sharing the trail with 200 others. User capacity is a value that is determined **exclusively** by trail users. It is not something that can be assigned by a planner or agency. Here again, knowledge of the OHV community is critical to competent planning.

Trail capacity as measured by the physical capacity of the trail and user capacity bear heavily on the design, location, size and number of trailheads and campgrounds providing access. During the planning phase or during the reconstruction of a trail system the planner must carefully analyze the needs and desires of those expected to use the area. At the same time, due consideration must be given to the type of outdoor recreation experience the agency can successfully provide.

If the desire of the users is to experience a motorized primitive experience, the rule of thumb is to design trailhead/campsite facilities equivalent to four users per mile of trail.

Understand that it is virtually impossible to achieve a primitive trail experience on a system that actually has four users on each mile of trail. The "rule of thumb" is used only to obtain the number of camping/trailhead spaces to be provided.

For example, if the planned trail system has the potential for 30 miles of trail and the experience level planned is primitive then the total size of all the trailheads connecting the trail system should not exceed 60 haul vehicles (users will generally average two trail bikes or ATVs per haul vehicle). There will generally be family members or others accompanying the riders who will not use the trail. All of the riders present will also not

generally all be out on the trail at the same time. The rule of thumb value accounts for these individuals. To keep the use experience primitive, camping/trailhead facilities should be small, numerous and widely dispersed.

On the other hand, if the trail will be used for organized events, there must be a suitable staging area that will accommodate a large number of recreationists and provide good access to the trail system. The planner needs to take into account the need to provide accommodations for the increased use. Give careful consideration to the physical capacity of the trail system and particularly to "trunk trails" that access the rest of the system. The writer's experience has been that some trails can withstand very heavy use if properly designed, constructed and maintained, provided that organized events are knowledgeably managed and limited to the time of year when the trails are least susceptible to wear.

Consult local clubs with event experience to determine how many riders could be expected to attend organized events. It is unlikely that any trail system would be designed only with large, organized events as the sole

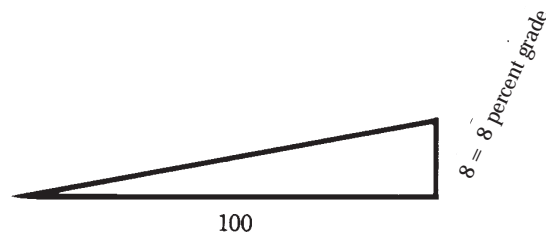

The slope of a trail or "grade" can be determined by calculating the rise or decrease in elevation over a measured horizontal distance.

use. If possible, provide small, dispersed trailhead and camping facilities as if the special event staging area did not exist.

For a typical trail, the rule of thumb is to design the system for 6 to 8 machines per mile of trail. This would also include the camping spots available. For example, for the 30-mile system with one 25-unit campground (two trail machines per unit), the total trailhead capacity should not exceed an additional 65 vehicles. Also take the dispersed camping units available to the trail system when determining trail system capacity.

PLOTTING THE TRAIL

The tools needed to project trail routes are:

- ◆ 7 1/2-minute U.S.G.S. contour maps or other large-scale contour map.
- ◆ Engineer's scale.
- ◆ Small set of dividers.
- ◆ Inventory.
- ◆ Aerial photos in stereopairs.
- ◆ Stereoscope.

Percent grade is an expression of the slope of a line. (Vertical distance x 100) divided by Horizontal Distance = Grade.

For example, if a trail climbs at the rate of 8 feet vertically in 40 feet of horizontal distance the grade is (8 times 100) divided by 40 = 20 percent.

Percent grade can also be thought of as the rise in feet per 100 feet of horizontal distance.

This handbook will always express the slope of a trail as a percent.

Contour maps have both a horizontal scale (i.e., 1 inch = 2000 feet) and a vertical contour interval (i.e., 40 feet). The horizontal scale and contour interval will normally be stated on the map. The statement 1 inch = 2000 feet means that 1 inch on the map equals 2000 feet on the ground. The contour interval of 40 feet means that

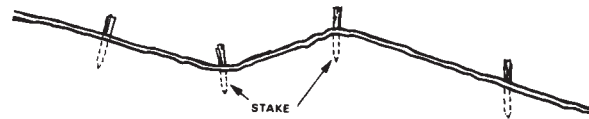
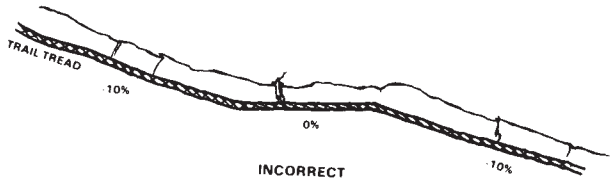
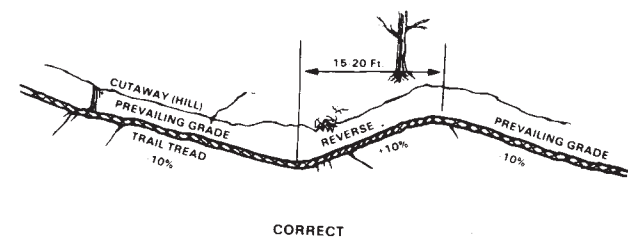
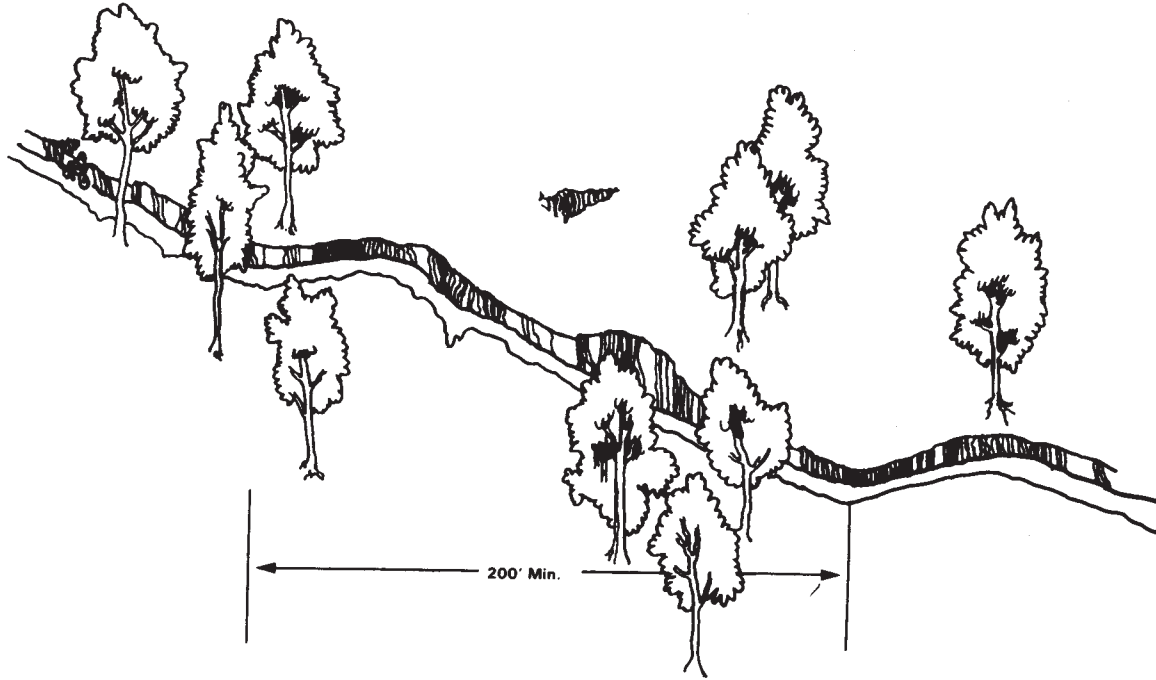

Drain Dips provide one of the most effective ways for reducing erosion from trail surfaces. Top, a completed section of trail incorporating two drain dips. There should be a minimum of 200 feet between each dip. Left, these drawings display correctly and incorrectly installed drain dips. Note the reversal of trail tread grade for 15 to 20 feet (top left). A mere leveling of the grade is insufficient to divert runoff (bottom left). Above, the dip must be staked to define where the trail should be constructed.

each successive contour line represents a change in elevation of 40 feet. Each time the proposed trail route crosses from one contour line to another the elevation change is 40 feet.

If we wish to use a 7-percent grade we know from the definition of grade that the trail gains 7 feet of elevation for every 100 feet of horizontal distance. The contour interval is 40 feet; therefore, if we divide the contour interval by the grade (40/7) we obtain the distance in hundreds of horizontal feet between contour intervals. In this case $40/7 = 5.714$. Multiply by 100 to get feet by simply moving the decimal point two places to the right. $5.714 \times 100 = 571.4$ horizontal feet between 40 foot contour intervals. Using an engineer's scale we set off 571 feet (0.286 inches) on the dividers. Use the dividers to project a 7-percent grade on the contour map by measuring a distance of 0.286 inches (571 feet) between successive contour intervals. In this manner any grade desired can be projected on the contour map.

DRAIN DIPS

By their nature, recreation trails -- be they trailbike, horse or hiker -- intercept a certain amount of surface water from snowmelt and rainfall. As runoff flows down a trail grade, it increases in volume and velocity. If uninterrupted it eventually develops sufficient energy to displace soil particles. Other things being equal, erosion will increase as the volume of water increases and the grade gets steeper. The trail manager must control this water in a manner that will prevent surface wash and tread erosion.

The best way, and in some cases the only way, to divert runoff from a trail is by using a simple structure known as a **DRAIN DIP**. This is a reverse in the grade of a trail that forces water to flow off of the trail surface. It is effective, inexpensive and easy to construct. In most cases drain dips must be designed into a trail before it is constructed, otherwise the portion of the trail leading into the bottom of the dip will be too steep. The absence of drain dips in an existing trail often indicates improper design. However, in very arid areas quite the opposite can be true as it may be desirable to direct water onto the trail to optimize bearing strength in the tread area.

Construction and maintenance crews often rely too heavily on small waterbars for erosion control. These generally fail after a season or so of use. These waterbars are sometimes a necessary afterthought to existing trails, while drain dips are much more effective but must generally be built into new trails when they are constructed.

The spacing or frequency of drain dips will depend on the prevailing grade, amount of runoff and the ability of the trail tread to resist displacement. Spacing has to be

determined by the trail locator on the ground through experience and observation of other trails -- preferably in the same vicinity.

If spacing is too short it may have an unfavorable impact on the recreation experience because of the bouncing "roller coaster" effect. If too long, tread loss may occur. The locator should design trails with grades that will not require drain dips closer than 200 feet apart, preferably farther. Soil scientists and hydrologists may be able to help determine appropriate spacing.

Note that if significant elevation must be lost between control points, the inclusion of drain dips will increase the length of the trail. This is because the grade is reversed for 15 to 20 feet each time a dip is installed. Trailriders view increasing the length of a trail as a benefit.

To design a drain dip, the trail locator simply reverses the prevailing grade of the trail for 15 to 20 feet. For example if the trail is running downhill at a 10 percent grade, the locator would run uphill for 15 to 20 feet at a 10 percent grade, then resume the prevailing downhill grade of 10 percent. In addition, drain dips should be outsloped slightly (about 10 percent) to ensure that water runs off the trail.

To obtain satisfactory results, stake each dip on the ground prior to construction. Stakes will act as a guide to construction so grade angle and distances will be consistent. Four stakes are required to adequately define each dip. Finished grade is at the point where each stake enters the ground. The astute trail locator will attempt to place drain dips where they avoid trees, large rocks and other features that increase construction costs.

DO:

- ◆ Design drain dips when the trail is located.
- ◆ Space drain dips to accommodate soil type, precipitation and trail gradient.
- ◆ Make certain that the grade is reversed, not just slackened.
- ◆ Make the reverse at least 15 feet long.

DO NOT:

- ◆ Attempt to develop drain dips on an existing trail with a steep grade.
- ◆ Attempt to use a zero grade instead of reversing.

Considering the benefits they provide, drain dips are one of the most effective trail structures a manager can employ.

THE FLEXIBLE WATER BAR

In some cases where drain dips were improperly designed or where existing trail is converted to a more managed style of motorized use, another successful



An All-Terrain Vehicle crosses a flexible water bar. Note how the belting allows passage with no changes in terrain to the rider.

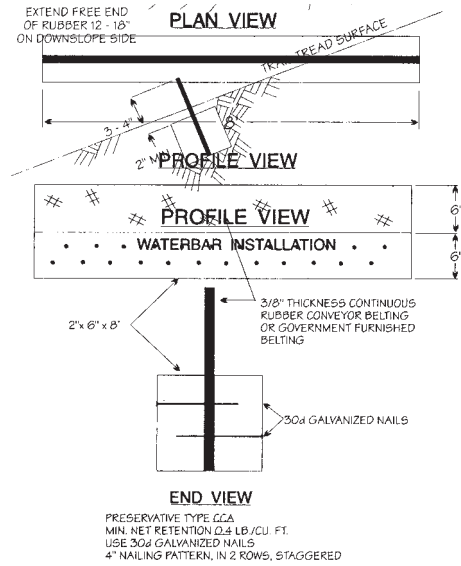

RUBBER BELTING WATERBAR

PLAN VIEW

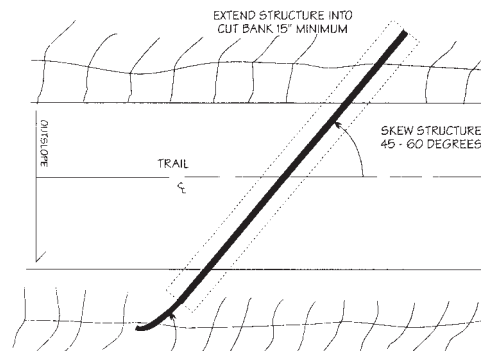

strategy has been employed. Employees of several forests have developed a continuous belting water bar that has worked very well.

This "flexible water bar" is built using new or used conveyor belting. Belting with minimum dimensions of 3/8" thick and 8 1/2" wide is sandwiched between two treated 2 x 6 boards which are then nailed together. Continuous belting should protrude above the trail bed no more than 3 1/2" and no less than 2 1/2". The length is determined by the trail tread width and it is recommended that a minimum of 12" be set into the cut bank and extend past the outer edge of the trail.

It is important that the structure be installed with a skew of 45 to 60 degrees to the centerline of the trail tread. This will ensure that it will be self-cleaning. A large stone should also be placed on the inside edge of the structure to discourage users from going around the device.

In colder climates, use belting with little or no reinforcing fibers. In test situations, fibers have wicked water into the belting where it freezes and splits it apart.

GRADE

Grade was defined earlier as the slope of a line, in this case the trail. Trail grade is critical both to user satisfaction and the stability of the trail tread. The first

limitation on grade is provided by the type of trail. We have specified a maximum sustained grade of 12 percent and a maximum pitch of 30 percent on More Difficult trails.

The second and more important grade limitation is imposed by site, soil conditions and precipitation. In Chapter 1, we talked about the relationship between soil type, grade and trail use. That information is put to use in selecting the maximum grade that may be used in each location. Before projecting grades on the contour map, determine the point at which rapid tread degradation begins to occur. Maximum grade should be established at 1 to 3 percent under the slope at which rapid tread



Ruts will develop if trails are run directly up the contour or slope instead of quartering across.

degradation begins. It is not necessary or even desirable to use maximum grades all the time, but it is critical to know what they are.

Building trails that are too steep for the site will result in expensive maintenance costs and may force the manager to relocate the trail entirely. Excessive grade is a frequent cause of trail failure. Similarly, the planner must seek out sites which will provide sustainable grades that approach the maximum allowed by the trail class. An occasional steep grade adds greatly to the riding experience. Fail to do this and rider dissatisfaction is likely. The key is to find the sites that will tolerate steep grades and include them in the plan. However, steep grades should not go directly up the slope.

Totally flat grades should be avoided. Always use at least a 2-percent grade to provide drainage. Roll the grade as necessary.

Avoid sensitive sites and locations where other management activities could disrupt trail use. **BE CERTAIN TO ROUTE THE TRAIL TO TAKE ADVANTAGE OF THE AMENITIES THAT MAKE THE RIDE**



Improper location: Trails should not be located in meadows.



Abandoned trails can be easily and effectively closed by filling with logs and brush.

ENJOYABLE, THINGS SUCH AS WATERFALLS, SCENIC VISTAS, LAKES AND THE LIKE. THIS IS CRITICAL -- WITHOUT THEM THE TRAIL WILL FAIL TO PROVIDE A QUALITY EXPERIENCE.

Many areas will already have existing trails. The planner must thoroughly study trail conditions as part of the inventory process. If properly designed and in good condition, incorporate existing trails into the trail system. However, if existing trails are poorly designed, improperly located or in very bad condition the planner must do a careful analysis and make the best possible choices.

Existing trails that are too steep and are eroding badly are prime candidates for abandonment and relocation. Trails in wet soil are another case that may call for relocation. Ask yourself if the trail problem can be solved or if it would be cheaper in the long run to



Above, improper location is the principal cause of trail problems. Trail bike volunteers quickly eliminated this situation with 150 feet of relocated trail. Below, problems solved: the relocated trail on stable ground.



relocate. For example: Would it cost less to repair the problem and maintain a given trail for 20 years or would it be cheaper to relocate the trail and maintain for 20 years?

ADDITIONAL CONSIDERATIONS

Analyze predicted construction and maintenance costs. Normally the choice is for the least expensive route to construct and maintain. However, if a more costly route will provide a scenic vista, access to a mountain lake or other desirable features, then the higher cost will be justified and often mandatory from the viewpoint of the user. Study the relationship between construction costs and maintenance costs.

Construction is normally a one-time cost, but maintenance costs will continue for the life of the trail. Situations are frequently encountered where additional construction expense will result in reduced maintenance costs over the long term.

Economics are only one consideration. If the existing

trail provides access to outstanding scenery or provides a particularly valuable riding experience, then cost may not be the overriding consideration. Examine and try to understand the values riders place on particular trails.

Don't be lulled into developing a low-quality trail plan merely to utilize existing trails. Rather, integrate existing trails into loops and develop a quality trail system that serves rider needs.

Strive to minimize the number of road crossings and maximize the distance between them. Never, under any circumstances, allow a trail to cross a road after a long, straight section. Always "dog leg" the trail just before the crossing to slow riders down.

The optimum slopes on which to locate trails is in the range of 20 to 70 percent. Below 20 percent there is the risk of inadequate drainage, above 70 percent construction costs accelerate rapidly.

Plot the Easiest trail loops first, then proceed on to the More Difficult and Most Difficult trails. Go to the field and conduct enough reconnaissance to be certain that the trail plan is feasible to locate and construct on the ground. Structure the system to be compatible with other activities, and modify other activities so they do not disrupt the trail system.

Mountain meadows present a special case for the trail planner. Their beauty and variety make them very desirable to view and enjoy. However, because of their fragile nature they must be treated with extra care. Locate



Shelters such as the one pictured above maintain the rustic appearance of the trail while providing an excellent facility for a rest site or camping area.

the trail close enough to the meadow that it may be viewed and enjoyed but not so close as to go through the meadow. A trail 50 feet or so into the trees will permit

enjoyment without damage. If extra protection is desired a barrier of logs may be placed between the meadow and the trail.

Plot trail routes until a complete trail system has been developed. The next step is to locate the trails on the ground.

KEEP IT RUSTIC

Motorcyclists and ATVers love the backwoods -- that much is plain to see. But the reasons why are as complex and varied as those who ride. Three of the most common reasons given for trailriding are enjoying nature, escaping



Proper location of this trail maintains the rustic appearance of the surrounding area.

the structured existence of urban living and the physical challenge of it all.

Riders like trails with an "unimproved" appearance, even though the trail was carefully planned and developed. The rider should never have to see the hidden culverts or carefully located collector ditches.

This rustic/natural/primitive theme applies as much to other signs, bridges and manmade structures as it does to scenic vistas and the terrain under wheel. It's not

important that riders know why a trail was constructed in a certain way, only that the trail is rustic and interesting.

Part of the fun of trail riding is the primitive nature of the sport. After putting in a 40-hour work week, trail riding enthusiasts are ready for a change of pace. Rather than the four-lane interstate, stop lights, lane changes and traffic jams that urbanites live with most of the time, motorcyclists want to see bridges made of hand-split wood, not expensive sawn lumber, they want trails with some of the obstacles left in so they can have the satisfaction of negotiating them. They want trails with lots of challenges or surprises (appropriate for each ability) including steep hills, tight turns and water crossings. Riders do not want a backwoods version of Wilshire Boulevard.

A bridge constructed for motorcyclists, for example, would ideally be constructed of all native materials, including the log stringers underneath, split logs for the deck and log wheel guards along both sides.

Not only are native materials more attractive to the enthusiast, they may be more economical and convenient to use than commercial lumber. The trees can be felled right at the site, then trimmed or split to construct the final product. Not only does this save the manager from having to purchase expensive lumber, but it also saves the additional inconvenience of transporting it to the site.

Having a rustic appearing motorcycle trail does not mean it is an unmaintained trail. Proper construction techniques and regular maintenance are critical to preserving attractive riding areas.

REVIEW

The following features exist on some of the best OHV trail systems in the world. Review your system to see how it stacks up.

- ◆ Locate campsites as far from main roads as possible, from a few to 20 miles. Most OHV recreationists prefer to camp where they may enjoy the experience of being separated from the rigid structures of modern civilization.
- ◆ While you may have a developed campground, keep most of them undeveloped. This is what riders prefer.
- ◆ Access the system from numerous, small, widely separated campgrounds/trailheads. Too much concentration on access trails from a single large campground or trailhead can detract from a quality wildland experience.
- ◆ Make two thirds of the trail "more difficult." This is the level preferred by most riders.
- ◆ Use loops to provide a variety of experiences to the riders. Do not allow a loop trail to suddenly jump from "easiest" to "more difficult." Always allow the opportunity to continue on a trail of the same class.

- ◆ Incorporate destinations such as mountain passes, peaks, vistas, abandoned mines, lakes, waterfalls and hot springs. These are critical to a high quality experience. Make the recreation experience inviting to those who use their time to explore, photograph, fish and take a dip. Do not chop up trails with roads. The rider should be able to get out on a trail experience without being overly reminded of civilization.
- ◆ The value of a road, any road, to the trail rider's recreation experience is very close to zero. If at all possible, the recreationist should be able to complete a loop without resorting to the use of a road.
- ◆ Use a single "easiest" trail to access trails from a campsite. Never use a campsite as part of a loop.
- ◆ Accommodate the inexperienced, the young and the less rigorous rider by placing most "easiest" trails near the campsites.

CHAPTER THREE

LOCATING THE TRAIL ON THE GROUND

Trail location is a continuation of the planning process that started with the inventory. The care used will bear heavily on the success or failure of the trail system. Location provides the final opportunity to discover and correct planning errors before funds are expended on the costly process of construction. An improperly located trail may result in high construction costs, high maintenance costs, user dissatisfaction, unnecessary environmental impacts or all four.

If the trail system plan was carefully developed with the benefit of adequate on-the-ground reconnaissance, the location process will proceed smoothly. If not, location may involve a great deal of additional work such as correcting unnecessary errors and reflagging grade lines.

Although trail location can be enjoyable and rewarding, it involves hard, time-consuming work. It requires the patience to reject, when necessary, hours (or even days) of hard work, and try again.

Trail location requires, at a minimum, the following equipment:

- ◆ A "work map." This should be a 7 1/2-minute U.S.G.S. Contour map with a projection of the proposed trail routes and location of campgrounds and trailheads, major control points, proposed grades, trail type and other useful information such as property boundaries, proposed road locations, timber harvest and the like.
- ◆ A clinometer or abney to measure slope and establish a grade line.
- ◆ Surveyors tape to mark the grade line and felt tip pen.
- ◆ An altimeter to measure elevation.
- ◆ Aerial photos if available and pocket stereoscope.
- ◆ A good pair of boots.
- ◆ Notebook and pencil.

Although not essential, the preferred order of trail location is to start with the Easiest trails.

THE DETAILED RECONNAISSANCE

First, refine the reconnaissance that was done in developing the trail system plan. Begin at a major control point, a trailhead for example, and walk through the approximate route of the access trail and trail loop. Project a rough line with the clinometer and walk it through. Flag points of concern with surveyor's tape.

Use the altimeter to establish the proposed location on ridges and in draws. For example, determine from the contour map (work map) the elevation at which a

proposed trail route is expected to cross a draw. Then using the altimeter you can find that location on the ground simply by moving up or down the draw until the desired elevation is found. The same technique can be used on ridges that can be identified on the map and on the ground. Flag these points with surveyor's tape, and



This rugged steep terrain is unsuitable for Easiest trails.

write some type of identification with a felt tip marker. Locating the proposed route on the aerial photos can help.

Keep in mind the class of trail being located. For example, do not locate an Easiest trail on a site subjecting riders to a high degree of exposure. Always think in terms of user satisfaction, construction costs, maintenance costs and environmental impacts. Carry a pocket notebook and make generous notes on conditions observed along the proposed route. Record items such as elevations of control points; construction conditions, including difficulty of excavation and grubbing; conditions that require blasting; stream crossings that require culverts, fords or bridges; and wet soil or other conditions that require special construction techniques. Record the location and elevation of potential sites for switchbacks.

When unacceptable conditions are found along the proposed route, modify the plan by changing part of the route. Find and make notes on feasible alternatives. For example, one may have to relocate to avoid an area that would require extensive blasting through solid rock. Continue the reconnaissance until a trail loop is completed. When the detailed reconnaissance is done,

you should have a good picture in mind of how the trail will develop and where it goes.

IMPROVE THE INITIAL PROJECTION

Next, improve the initial projection made in the trail system plan. Walk over the area at least two or three



Rock outcroppings often require blasting to build a trail.

times and look for ways to improve the initial projection.

Most important is to look for ways to make the trail more enjoyable to the trailbike or ATV recreationist. Can you find a waterfall or an interesting rock formation that would enhance the recreation experience? Can the trail be rerouted to vista points not included in the original projection? Never forget that the sole reason for the trail's existence is to provide recreational enjoyment.

Improving the trail experience will usually justify increasing expenditures. At the same time, look diligently for ways to locate the trail that will reduce construction or maintenance costs without compromising the quality of the trail experience.

During both location and construction, endeavor to fit the trail to the ground so that it lies easy on the land and provides a high quality riding experience. Alignment should be curvilinear. Avoid long, straight tangents, either horizontal or vertical. The trail should traverse across slopes rather than shoot directly up or down.

FLAG THE GRADE LINE

Once the planner is satisfied with the proposed route and adjustments have been made to the plan, it is time to begin flagging a grade line. Obtain grades from the adjusted trail system plan. Flagging is usually done by a two-person crew. Commencing at a major control point, such as a trailhead, a strip of surveyors tape is tied, at



The trail planner should identify points of interest like this cliff and vista. Higher construction costs are justified in order to provide a satisfying trail experience.

eye level, to a tree or bush. One person then proceeds ahead while the other remains with the clinometer at the starting point. The person (instrument technician) at the starting point uses the clinometer (or abney) to set the flag technician on grade.

If the crew people are of the same height, it is customary to sight from eye level to eye level. For example, if a 10 percent grade is being run, the instrument technician would direct the flag technician to go ahead along line and to move up or downhill until exactly on grade at eye level. When on grade, the flag technician ties a strip of surveyors tape at eye level and proceeds ahead on line. Meanwhile, the instrument technician moves up to the point just set. The procedure is repeated to establish a continuous grade line. Sometimes trail locators work alone and simply shoot back at the previous flag.

Locate drain dips when the grade is run. Obtain drain dip spacing from the trail system plan. Identify drain dips by using surveyors ribbon of a different color from that on the rest of the grade line. Properly developed drain dips are the most effective drainage structure we have.

In practice, the grade line will often intersect obstacles such as large trees and rocks. Avoid these to escape high construction costs. To avoid such obstacles, pitch or roll the grade so the trail will be above or below. In many instances, grade can be rolled both to avoid the obstacle



This water-saturated trail tread indicates improper location, improper design or both. This trail should have had an interceptor ditch located 10 feet uphill (See interceptor ditches).

and to create a drain dip. Use pitches in grade to get back on line after avoiding an obstacle.

It is often advantageous to build "slack" into the grade line to make it easier to avoid obstacles. On a climbing trail, the grade is increased 2 or 3 percent for 200 feet, then returned to the prevailing value. This will place the

line 4 to 6 feet higher than it needs to be to intersect the next control point. Since the line is higher than it needs to be, it can easily be rolled under an obstacle and still be high enough to intersect with the next control point.

Even with the best planning and reconnaissance, trail location is a trial-and-error process. At times, the grade



This properly constructed collector ditch intercepts ground water before it can saturate the trail tread.

line will miss major control points. When this happens, go back and find a workable route.

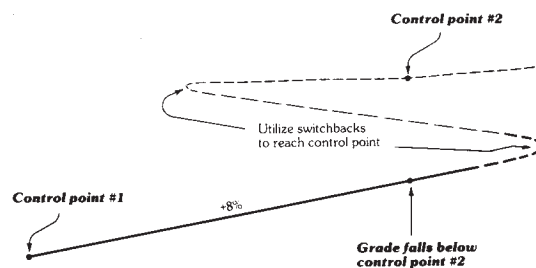
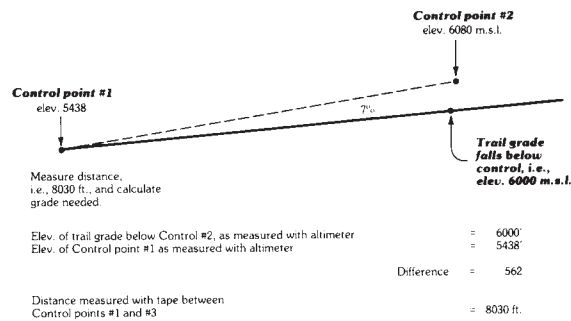
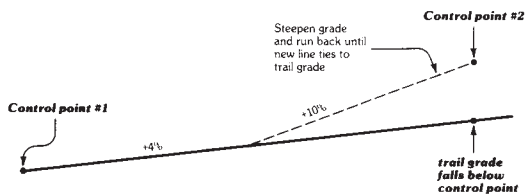
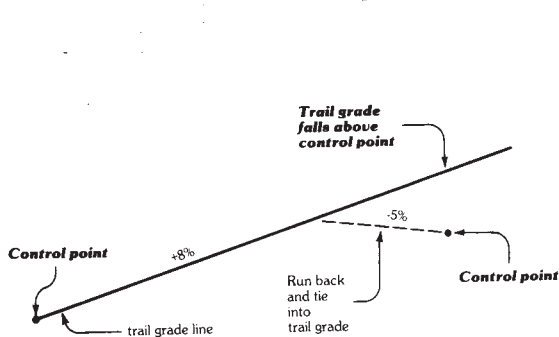

When the trail grade falls above the control point, the situation can easily be remedied by starting at the control point and running back to the trail line on a positive grade.

On the other hand, when the trail grade falls below the control point, the cure can be more difficult. Either measure the difference in elevation (with the altimeter) between the control and the point where the trail grade falls and estimate or measure the distance to the previous control point, then using the formula given earlier calculate what grade would be needed. Or start at the control point and run back at a grade steeper than that initially used until the trail grade is intersected. Alternatively, extend the trail and switchback twice to reach the control without steepening the grade.

As the flag line progresses from control point to control point, it is essential to identify conditions that will

cause problems during construction or later when the trail is in use. Find solutions to these problems during location for implementation during construction. Wet or damp soil is a frequent cause of trail problems. A number of techniques included later in the book will help deal with this situation. Usually the best way to handle these problems is to reroute and avoid them.

Sometimes avoidance is not practical, and sometimes a problem area can be handled in such a manner that it will add to the trail-riding experience. For example, the technique described for handling certain talus slopes adds interesting variety to any trail ride.

Location continues from control to control until the trail loop is complete. The planner may wish to make a final walk-through to add flags for better control of construction or construction stakes.



This well-designed trail lays easily on the terrain and creates virtually no adverse impact. There is adequate sideslope to provide drainage away from the trail surface.

CHAPTER FOUR CONSTRUCTION

Construction is the final stage of trail development. Much has been written about the process and procedures of recreational trail construction, most of which is directly applicable to the building of off-highway motorcycle and ATV trails.

I again impress upon the reader the importance of building and maintaining trails that are primitive and rustic in appearance. Don't destroy the potential for a fine trail by overbuilding. Both before and during construction there must be sufficient guidance to the builder to ensure that the completed facility will closely resemble the trail the planner had in mind.

The degree of control exercised over the construction process varies with the type of crew and the complexity of the job. Experienced crews require less guidance than those who are new. Difficult terrain and special designs require explicit directions and close supervision. For the wider trails used by ATVs, it may be more cost effective to use mechanized trail building equipment.

SETTING UP CONSTRUCTION

Just before construction the planner should walk the flagline and add enough additional flags to define sufficiently where to build the trail. Use survey stakes in

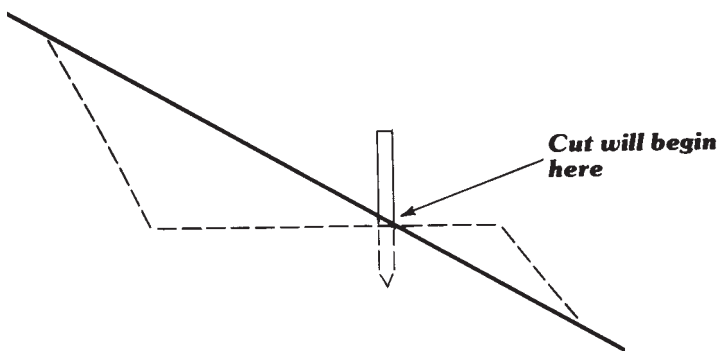

critical locations. Wherever using special tread protection devices, precisely define the location with survey stakes.

The construction crew must know exactly how much leeway they have to deviate from the flagged location. Review the trail specifications with the crew chief. Make certain they are clearly understood.

One convenient way to stake the location in critical areas is to place survey stakes on grade at the point

where the cut should begin.

Since stakes control alignment as well as grade, space them closely enough to provide a smooth, flowing trail. In some cases this may require stakes as close as 4 to 6 feet apart.

Fund availability often dictates that trail construction be carried out over a time, perhaps as long as three to five years or more. Since it is necessary to get trails into operation quickly, planning includes making careful and logical choices on the order in which trails will be constructed. The presence of an existing trail system will make the task easier, since development would tend to expand recreation opportunities rather than provide for needs previously unmet.

However, where there is existing use, construction must not disrupt trail use. For example, when relocating an existing trail, complete and open for use the new or relocated trail before closing and putting to bed the old one.

Knowledge of the recreation becomes important or even critical when selecting the order of development. Where there is existing use, spend time on the ground with trail riders to study use patterns and preferences. It is always desirable to tie trail systems together to form complete loops very early in the development process. Give a high priority to the relocation or repair of existing trails in poor condition. Heed one caveat: Don't expend all of your time and resources repairing existing trail to the exclusion of new construction. Riders are always eager to see the development of new routes and additional mileage. Failure to provide them may lead to dissatisfaction.

If all (or most) of the trails are new development or there is little existing use in the area, the order of development can be more flexible. A logical way to continue is first to develop one complete loop of Easiest trail, then develop loops of More Difficult until 60 or so miles of trail are in operation. Then complete the system in whatever order is most convenient and economical. Everyone can use the Easiest trail, and a majority of riders use More Difficult trail. A 60-mile system should provide enough trails for casual riding while the system is being completed.

Trailheads and camping facilities must fit into the picture as well. Normally, give trails your top priority. Many riders prefer camping facilities with minimal development. The planner would do well to sound out local and regional

preferences for the type of facilities.

In many regions of the country, climatic influences will have a significant impact on the time, if not the order, of construction. Heavy snowpack at high elevations usually limits the construction season. Give thought to the most effective deployment of crews. By starting out in the spring at low elevation, moving up to high elevation for the summer then back down in the fall, it is often possible to stretch the construction season and offer seasonal trail crews a longer period of employment. Length of employment can be a factor in obtaining and keeping qualified personnel.

The Agency Crew

The personnel used to construct the trail may be an agency or department crew, contractors or volunteers. Each type of crew has its advantages and disadvantages. Agency crews probably offer the greatest degree of flexibility. There is no need to make complicated and sometimes costly contract changes when coming across unexpected conditions in the field. Simply tell the crew what to do to allow for the condition. In emergency situations the crew may be used as a readily available source of labor for forest fire fighting, for example. A well-trained crew with competent supervision can build high-quality trails with a minimum of ground control (flagging stakes, etc.). They can take care of most contingencies with no disruption in the work. On the other hand, the agency must hire, fire, train, supervise and account for an entire crew. Equipment and transportation, and often housing, must be provided.

The Contractor Crew

Building by contract enables the agency to obtain the necessary equipment and personnel on a project-by-project basis. Personnel, equipment, supervision, transportation and the like are the responsibility of the contractor. The contracting manager must allocate time to write detailed and carefully thought-out contracts and spell all work out in detail in clear language understood by both parties. When unexpected conditions are encountered, change orders must be negotiated and agreed to. It will usually be desirable to have more control on the ground to avoid misunderstanding. The agency may not have the flexibility to use the crew for other operations. The quality of work done and the cooperation varies with individual contractors. It is more difficult and expensive to discharge an unsatisfactory contractor than to discipline an unsatisfactory crew. Experienced personnel should perform contract preparation and administration.

Volunteers

Volunteers can be an effective way to construct certain trails, but they are not "free" labor. Volunteer trailbike and ATV enthusiasts offer the land manager an opportunity to accomplish a great deal of work in a short

time. If the manager and planner do their parts effectively, volunteers will be highly motivated to complete specific tasks in a short time. The planner must make certain that tasks are of interest and will be of tangible benefit to the volunteers. Train volunteer leaders and provide competent agency supervision. Clearly define tasks beforehand and have the work laid out and ready to go. Work can be accomplished at very substantial cost and time savings, but do not use volunteers to the point that they become



The Morrison Trail Blazer and other similar machines are effective trail building tools.

bored or disinterested. The amount of time volunteers will wish to spend can be expected to vary widely from group to group and project to project. The volunteers make that decision, NOT the agency. Many managers find that it is most efficient to use volunteers for no more than a half-day of vigorous labor at a time.

Each of the three different types of personnel described here can be an effective trail construction work force. I recommend that the planner have experience constructing trail with agency personnel before attempting to contract volunteers.

BY HAND OR MACHINE

Another choice to make is whether to use mechanized equipment or hand construction. The writer prefers to build



Hand construction is used on More Difficult and Most Difficult trails.

Easiest trail with a mechanized trail machine, and to build More Difficult and Most Difficult trails by hand construction. For the most part, trail machines do not build motorcycle trails narrow or tight enough to be classed as More Difficult or Most Difficult. Where they can be used, trail machines are capable of rapidly constructing high-quality trail with a minimum of personnel.

Equipment such as rock drills and chainsaws can and should be used on all trails. Try using trailbikes or ATVs to transport crew and materials to the work site. Using trailbikes or ATVs offers an additional benefit in that trail problems are often discovered while the crew is still on the work site!

CLEARING

CLEARING is one of the first construction activities to



Trees located on the downhill side help to center traffic on the trail.

take place in forested terrain. Design criteria specify that less clearing will be done as trails become progressively more primitive; i.e., advancing from Easiest to More Difficult to Most Difficult. It is important to be familiar with the operation of trailbikes.

For instance, trailbikes are leaned over to the side when they are turned, and therefore it is important to

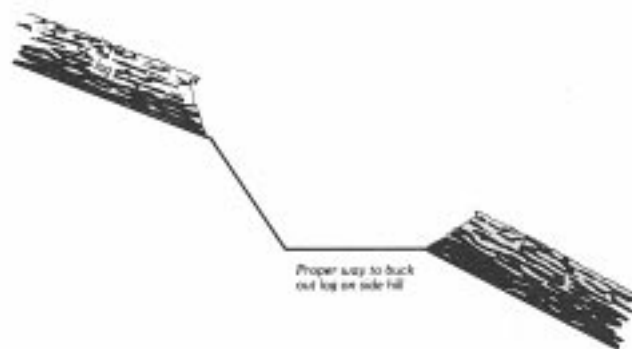

Logs when properly removed, as shown above, present no danger to the trail rider. The example below demonstrates how improperly "bucked" logs can create a hazard.



provide adequate clearing on the inside of the curve. It is desirable from a maintenance point of view to maintain traffic in the center or closer to the "cut" (uphill) side of the trail. Leaving as many trees as possible close to the trail on the downhill side will help provide centering. Similarly, a thorough job of clearing on the uphill side will aid in centering traffic. If the trail is poorly cleared on the

uphill side, traffic will tend to ride on the outer edge or fill portion of the treadway. This is the weakest portion of the trail and damage to the fill may result. On all classes of trail it is critical to remove completely all stumps from the vicinity of the treadway. Short stumps can cause serious foot injuries. It is better to leave the entire tree than to leave a stump next to the treadway.

When removing large logs, the cut should start 6 inches or more from the edge of the tread and slope away at a 30-degree angle. On the uphill side the cut should start at the top of the cut slope.



"Full Bench" construction is often required on steep slopes or weak soils. Note how this trail has slipped downhill.

EXCAVATION

EXCAVATION, particularly on steep slopes, is the most time-consuming operation in trail construction. To some degree the amount of excavation will vary with trail width, soil strength and side slope. An Easiest trail, for example, is normally wider and given the same location requires more excavation than a Most Difficult trail. On steep sideslopes it will often be necessary to develop a "full bench" trail, whereas on moderate side slopes part of the trail can be on fill. Local experience will be necessary to determine which slopes, trail widths and soil types require full bench construction. Take care to dispose of waste excavation so the trail is not excessively wide.

When excavating the trail, develop a backslope that is compatible with the ability of the soil to stand without raveling or sliding. For most soils a 1 to 1 backslope is acceptable. Solid or semisolid rock will stand at a steeper slope, while weaker soils may require a slope as low as 2 to 1.

Except on outside corners it is not a good practice to leave a berm on the outer edge of the trail. Berms trap water on the tread and may saturate the trail and promote erosion. Remove berms when giving the trail a final dressing at the completion of construction.



When backslopes are too steep, material will slough onto the trail.

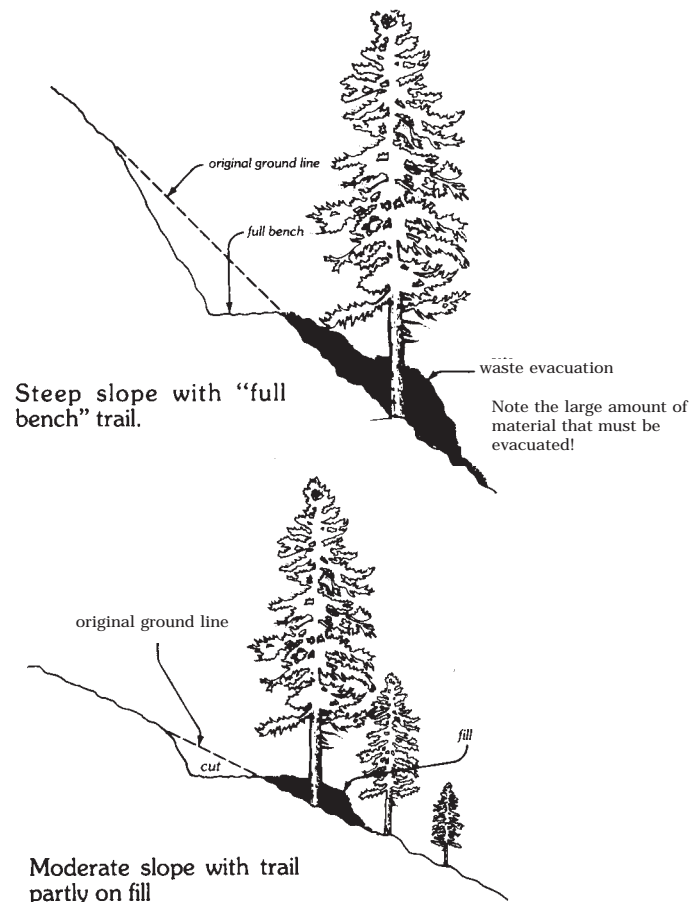

Steep slope with "full bench" trail.

waste evacuation

Note the large amount of material that must be evacuated!

Moderate slope with trail partly on fill

Local experience will be necessary to determine which slopes are appropriate for cut trails, trail widths and to identify soil types.

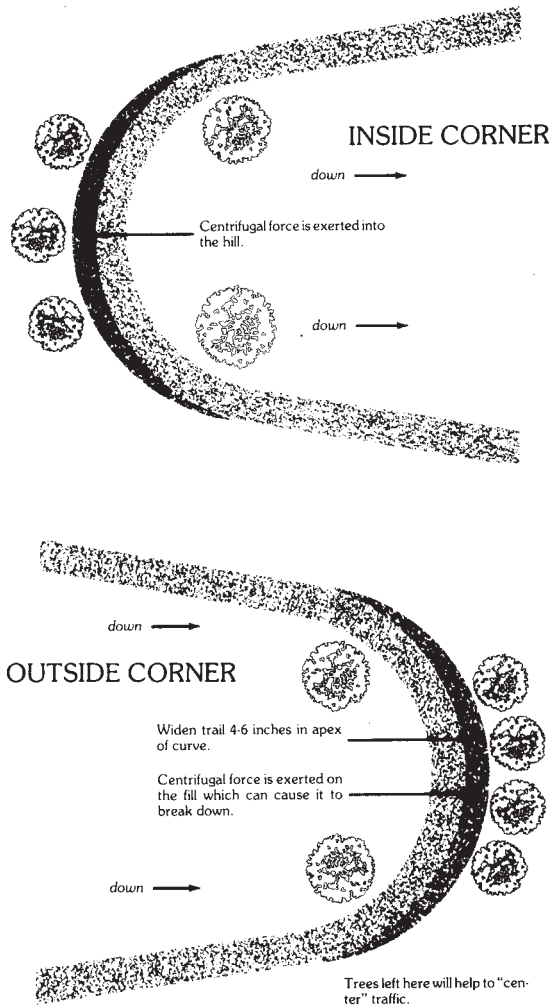

INSIDE CORNERS AND OUTSIDE CORNERS

When a rider negotiates a corner the trailbike is leaned over and centrifugal force is exerted on the tread. If the force is exerted on the cut side of the trail (inside corner) all is well and good. The cut side is the most stable part of the trail prism. If, however, the force is exerted on the fill side (outside corner) there is a tendency for excessive wear unless something is done to reduce the impact. Widen the trail on outside corners by 4 to 10 inches for motorcycles and 12 to 24 inches for ATVs. Take care to ensure that the tread does not slope outward through the curve.

SPECIAL TRAIL DESIGN AND REINFORCEMENT TECHNIQUES

CROSSING TALUS RUBBLE

At one time or other, many trail planners will

encounter talus rubble. At first glance, rubble fields appear to be impossible sites for trail development. Selection of an alternate route may seem to be the only workable solution. Fortunately, relocation is not always necessary. If the rubble is stable, it can usually be traversed with a trail entirely suitable for trailbike travel.

Stability implies that the talus is not actively moving downhill under the force of gravity or by the weight of a snowpack and that it will not become active if a trail is constructed. If the material is composed primarily of larger stones (4 inches diameter or larger), shows no visible indication of recent movement and is situated on a moderate sideslope (under 25 percent), then it is probably a suitable site for trail development. In borderline cases, it's worthwhile to consult a geologist.

Location Upon ascertaining stability, the next step is to select the best location for the trail and mark it with surveyors tape. Stay on stable ground, try to keep the grade under 15 percent, avoid large rocks that cannot be moved by hand and cross the talus with the most direct route feasible. Constructing trail through talus is hard, expensive work, so before you start, go back and take a second look at your location. Is it the best alternative?

Construction Begin construction by removing the



This short section of trail through talus adds variety to the trailriding experience.

larger rock from a linear path 3 to 3 1/2 feet wide for motorcycles and 4 to 6 feet wide for ATVs. Place this material on the downhill side of the trail where it won't roll back into the travelway. In some cases it may be desirable to use explosives to reduce large rocks to workable size. This involves placing charges so the material is broken up but not lost. The use of explosives requires the services of properly trained and licensed personnel.

After removing or breaking up the larger rock, use smaller stones to fill the voids and create a level trail bed. This will often require importing material from outside of the travelway. The more voids that are filled, the better because this will help to reduce the loss of surfacing.

The last step in construction is to haul and place a 6- to 8-inch lift of cushion material for the final surface. Surface material should consist of common earth with a good mixture of clay and small stones. Moving surface material is both time-consuming and expensive. Take time to locate the source that will provide the shortest haul distance. If the trail is to be designated Most Difficult, the surfacing may not be necessary.

A secondary benefit of the talus trail is that it provides variety to the riding experience. This is extremely important to the trailbike enthusiast.

COLLECTOR DITCHES

Trails that remain wet throughout the use season often develop ruts that require extra maintenance and repair. Such trails also present environmental problems and unnecessary rider hazards. The best solution is to avoid wet areas during trail location, but at times it is impossible to do so. Furthermore, the situation is often found on very old trails. Trail managers need a solution to this problem that is effective, inexpensive and permanent.

One technique that has been particularly successful in eliminating rutting and drainage problems is the collector ditch. This type of drainage structure is applicable in situations where ground slope is sufficient to provide drainage, usually 5 percent or more. The structure has four parts: (1) shallow channel(s) upslope from the trail to intercept ground water or surface flow; (2) lead-in ditch; (3) recessed culvert inlet; and (4) corrugated metal or PVC culvert pipe. The collector ditch functions to prevent saturation of the trail prism by intercepting seepage as it flows downslope, then routing it under the trail through a culvert before the water can saturate the trail tread.

Location The initial step in development of a collector ditch is on-the-ground planning. First, determine the extent of trail saturation, then lay out interceptor channels that are long enough to collect existing water. Use an abney or clinometer to locate channels on grades of 2 percent or more. Slope them to a lead-in channel.

For rider safety, ditch effectiveness and aesthetic considerations, interceptor channels must be uphill from and no closer than 5 feet to the trail. Ditches parallel and directly next to the trail are a rider hazard and may saturate the trail prism through capillary action. Adjacent ditches are also undesirable because of their visibility.

Construction Next, locate the lead-in ditch, recessed catch basin and culvert. For best results choose a location that is easy to dig and provides a good

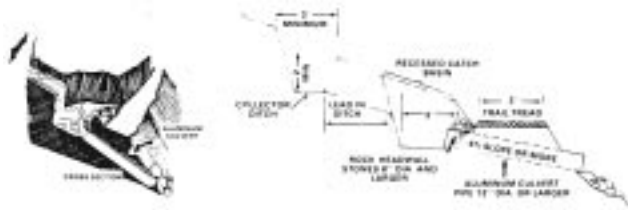

Collector ditches prevent water seepage in trail areas by intercepting supply. Surface the trail with native rock, or if a suitable material is not available, use crushed rock. Surface depth will vary 2 to 6 inches (loose measure) depending on conditions.

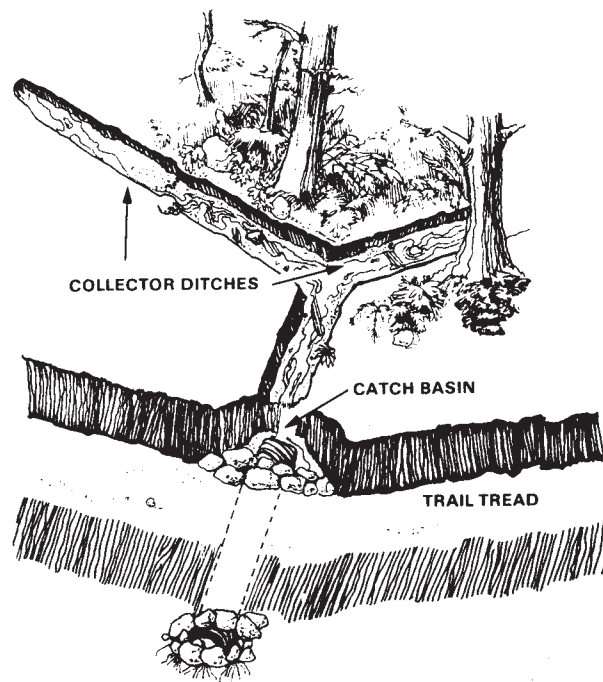

drainage at the culvert outlet. As an added safety feature, widen each side of the trail directly next to the culvert and catch basin by 6 inches for motorcycles and about 12 inches for ATVs.

Culverts must be of sufficient diameter to accommodate the flow of water (12 inches is the minimum). Determine the culvert length while you are in the field. Culverts must have at least one foot of cover over the top.

Mark the location with survey stakes to provide direction for construction crews.

In wet areas, it is often desirable to surface the trail with native rock or crushed stone. Construction may be done by hand, with high explosives or, if the ground is sufficiently stable, by machine. Dig out the catchbasins and culvert lays.

Finally, construct a rock headwall with stones 8 inches in diameter or larger. Place the surfacing (if needed) and the job is complete.

USING PUNCHEON TO CROSS WET SOIL

In most parts of the country OHV trails will occasionally have to cross wet or swampy ground. When this occurs use an artificial tread to protect the underlying soil.

Several options are available with varying degrees of cost and effectiveness. The planner's task is to select the least expensive treatment that will effectively do the job.

Because of the high flotation character of ATV tires and the low pressure exerted on the ground, any of the following armoring techniques for trailbikes will be sufficient for ATVs.

Collector ditches are often sufficient, but at other times turnpike, corduroy or rock ballast will be the best choice. In the worst cases, however, a puncheon trail may be the only feasible way to utilize a particular location. When correctly located and skillfully constructed, hand-split puncheon is an aesthetically pleasing trail structure that effectively protects the underlying soil.

Puncheon is similar to a bridge in appearance. It consists of:

- (1) sill logs that rest on the ground;
- (2) log stringers that rest on the sills;
- (3) decking spiked to the stringers; and
- (4) wheel guards spiked to the decking.

Before the planner decides to use puncheon, several criteria need to be considered and met:

- ◆ The finished grade must be nearly flat, or in any case

not in excess of 4 percent.

- ◆ Ground sideslopes must be moderate, preferably not over 15-20 percent. The surface of the puncheon must be level.
- ◆ The location must be such that the alignment is nearly straight. Curves, if any, must be very gentle. Deflection angles should not exceed 5 degrees.
- ◆ The use of puncheon must be economically feasible. Make certain that some other treatment won't work better.
- ◆ Do not use puncheon as a way to avoid the hard work of reconnaissance and design. If there is a better route, find it. Puncheon is best utilized to cross short stretches of wet, unstable soil that does not have sufficient bearing capacity to support turnpike or an armored tread. It should not be used for distances greater than 300 feet in any one section. Longer distances usually indicate insufficient time spent on trail location, create unnecessary expense and become unpleasant to ride.

If puncheon is determined to be the best choice, proceed with layout and construction.

Layout Select a location that meets the criteria for grade, sideslope and alignment. Favor the most stable location feasible. Select a shorter route over a longer one. Stake the centerline on the ground. If the construction crew is not experienced at building puncheon, the planner should measure out and mark the location of the sills. Some sites may require extra sills to provide sufficient load-bearing surface to support the structure and traffic. If so, stake the location of the added sills on the ground.

Locate the construction material to be used and make

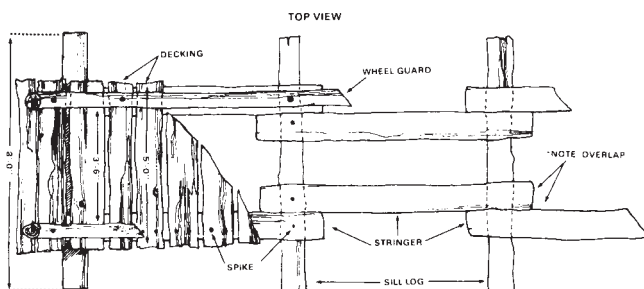

Puncheon is an effective method for elevating trail surfaces in locations where it is necessary for the trail to cross wet soils.

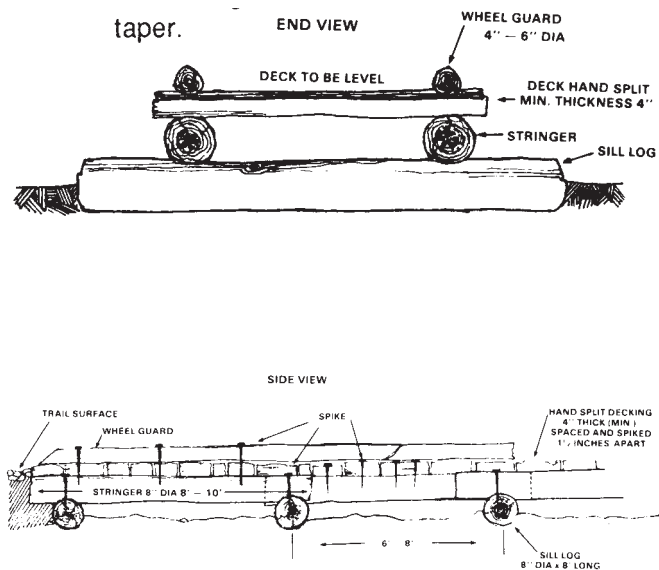

Turnpike is an effective trail reinforcement technique for trail surfaces that cross damp soils.

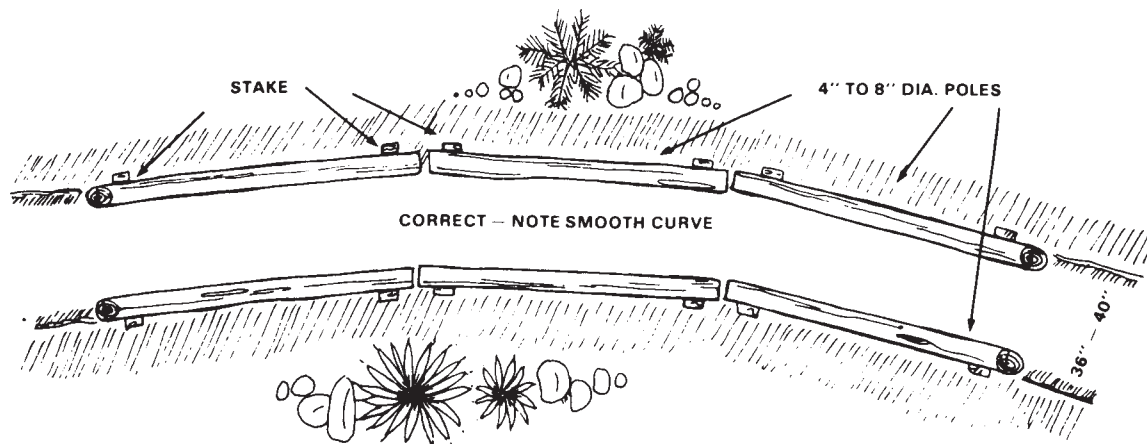
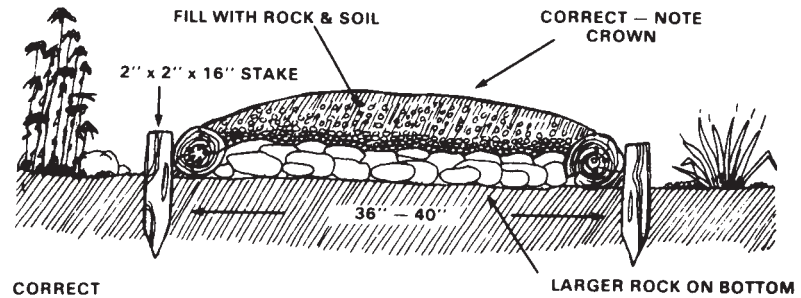

certain it is available in sufficient quantity. Determine the method of transporting materials and estimate the man-hours and equipment needed to do the job.

Construction

- ◆ Cut, peel and place sills and stringers. Dig out under sills or notch sills and stringers as necessary to level. Use dimensions as shown in the diagrams. When leveling is complete, spike the stringers to the sills. Stringers should be conifer with minimum taper.
- ◆ Split the decking from straight grained wood such as cedar, Western larch, Douglas fir, etc. Since wood does not always split evenly, trim the decking to fit. After cutting it to length with a chainsaw, use a sledge hammer, steel wedges and a froe to split the decking. Make certain that edges of the decking are square. A less desirable alternative is to rip the decking with a chainsaw. Use roughcut lumber only as a LAST RESORT.
- ◆ Fit the decking to the stringer and spike in place. Trim as necessary to obtain a snug fit. Make sure there is full contact between the decking and the stringers. It may be convenient to cut a block of wood one and a

half inches wide to space the decking evenly.

- ◆ Cut, peel and spike the wheel guards in place.
- ◆ Construct the approaches at each end and the job is complete.

Aesthetics To provide a primitive appearance compatible with the back country trailriding experience, use native materials and hand split decking.

USING TURNPIKE FOR DAMP TRAILS

Turnpike is a time-tested technique used to establish stable trail tread across damp soil. Turnpike is a simple trail tread elevated 4 to 8 inches above natural ground. Like all tread protection devices, do not use turnpike as a substitute for proper trail location. However, it is an effective and aesthetically pleasing way to prevent tread rutting on damp soil.

Procedure

- ◆ Determine the location and stake centerline. Favor sites with the least groundwater, and least slope. Lay out tangents and smooth gentle curves.
- ◆ Clear the vegetation for 2 feet on both sides of centerline.
- ◆ Cut straight poles with a minimum diameter of 4

inches and remove the bark. (Select poles with minimum taper. A rot-resistant species with a maximum diameter of 8 inches is suggested).

- ◆ Place poles end to end on the ground, 18 to 20 inches on both sides of centerline (36 to 48 inches for ATVs). Drive stakes on the outside of the poles to hold them in place.
- ◆ Fill the space between the poles with soil and rock. Place larger rock on the bottom. Make certain that the fill contains a high proportion of rock aggregate. Otherwise rutting may continue.
- ◆ Crown the fill to provide drainage.
- ◆ After use has compacted the fill for a year, add new material to rebuild the crown. Thereafter maintenance should be minimal.

In some cases, it is necessary to develop collector ditches to drain the soil of water traveling down the slope. Collector ditches intercept water as it flows downslope and before it reaches the trail tread. In this event, use culverts to route water under the turnpike.

Geotextile fabric may be placed directly on top of natural ground if additional bearing strength is required. Geotextile fabric is a fibrous material that can usually be obtained from road construction companies.

If the soil is too wet for turnpike, it will be necessary to use another treatment such as puncheon.

USING CORDUROY

Corduroy comes from the days of horse logging when skid trails were built on soft terrain by laying poles perpendicular to the direction of travel. With a few modifications, this technique has been adapted to trailbike trails for use in crossing wet soil. The refined version of trail corduroy consists of split planking nailed to buried stringers. Although not often recommended, the technique can at times be a useful tool for the trailbike trail planner.

The advantages of corduroy are its ease of construction and its use of less material of lower quality than puncheon. The disadvantage is that the decay rate is likely to be high because of its continuous contact with wet ground.

Corduroy, puncheon and even turnpike are used under similar conditions, but the trail planner must consider available materials, urgency for repairs and time and money necessary before choosing the appropriate tread armor. If the planner wishes to

suspend the planks free of the ground, then it is necessary to construct puncheon instead of corduroy. Since corduroy doesn't support a suspended load, it can be constructed of lighter material. Corduroy also tends to provide poor traction for tires, which make grade, alignment, location and leveling critical. If these things are ignored, safety problems may result.

Location Corduroy is suitable only for locations where ground slope is minimal. The cross section (slope perpendicular to the direction of travel) should not exceed 15 percent and the grade of the corduroy should not exceed 2 to 3 percent. Alignment must be straight due to the slipperiness of corduroy in turns.

Accomplish layout by staking two parallel straight lines 24 to 30 inches apart for motorcycles, 36 to 48 inches apart for ATVs. Continue the lines for the length of corduroy and serve as the centerline of the stringers.

Design Construct corduroy of small poles and split (not sawn) planking. Split planking provides greater traction under wet conditions than sawn lumber and is more aesthetically acceptable. Stringer poles should be 4 to 8 inches in diameter, while split planking should be 2 to 4 inches thick and 42 inches long for motorcycles, 72 inches long for ATVs.

Place the poles or stringers in parallel trenches dug according to the stake lines mentioned above (24 to 30 inches apart for motorcycles, 36 to 48 inches apart for ATVs). Depth of the trenches should match the diameter of the poles used for stringers. The combination of stringer diameter and trench depth must allow the planking to rest on the ground. Wheel guards at the edge of the corduroy are not required because the structure is at ground level.

Construction

- ◆ Start by clearing all material on either side of the centerline, 30 inches for motorcycle trails, 48 inches for ATVs.
- ◆ Level the ground 60 inches wide for trailbikes, 80 inches for ATV trails.
- ◆ Cut stringers and remove the bark. Try to select poles with minimum taper.
- ◆ Lay the stringers out on the ground adjacent to the staked centerline. Allow stringers to overlap 24 to 30 inches at each joint.
- ◆ Dig trenches for the stringers and match the diameter

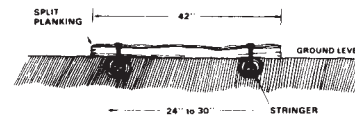
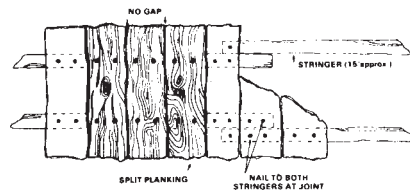

Corduroy is also an effective technique for reinforcing trail treads which cross wet soils. It is similar to the reinforcement technique puncheon, although corduroy is easier to construct and less costly.

with the depth.

- ◆ Place the stringers in the trenches and level.
- ◆ Split the planking and nail to the stringers. Lay planking tightly together with no gap. Always make certain the rough side of the planking faces up for better traction.
- ◆ At joints, nail the planking to both stringers. Select rot-resistant species for stringers and planking.

MAKE CERTAIN THE PLANKING IS LEVEL AND RESTS FIRMLY ON THE GROUND. There should be no suspended load at any point. Make certain that nails and stringers are sized to provide sufficient retention so planking will not loosen with traffic.

Corduroy is a quick, inexpensive way to stabilize wet trailbike trails and can last for several years. Consider its use for your trails.

PAVED STREAM CROSSINGS

CAUTION: The paving idea presented here is not recommended for mountain streams. If you cannot ride across the natural stream bed of a mountain stream, you most likely need a bridge. This technique may be appropriate for non-mountainous areas.

Streams may be crossed by "paving" the stream bed with rocks fitted together to make a stable surface for trailbikes. Take care to note whether the stream banks will need reinforcement to prevent erosion.

If the banks are too steep to provide good entry and



Flat stones work as effective materials for creating paved stream crossings.

exit, or if the soil surrounding the stream is swampy, the planner may want to consider using a bridge to cross the waterway. Similar to puncheon construction, bridge material preferably should be a rustic design.

SHALLOW STREAM FORDS

CAUTION: The fording idea presented here is not recommended for mountain streams. If you cannot ride across the natural stream bed of a mountain stream, you most likely need a bridge. This technique may be appropriate for non-mountainous areas.

Another alternative for stream crossings is the ford. In this situation, widen the approach, 36 inches for trailbikes and 72 inches for ATV use, and be as level as possible.

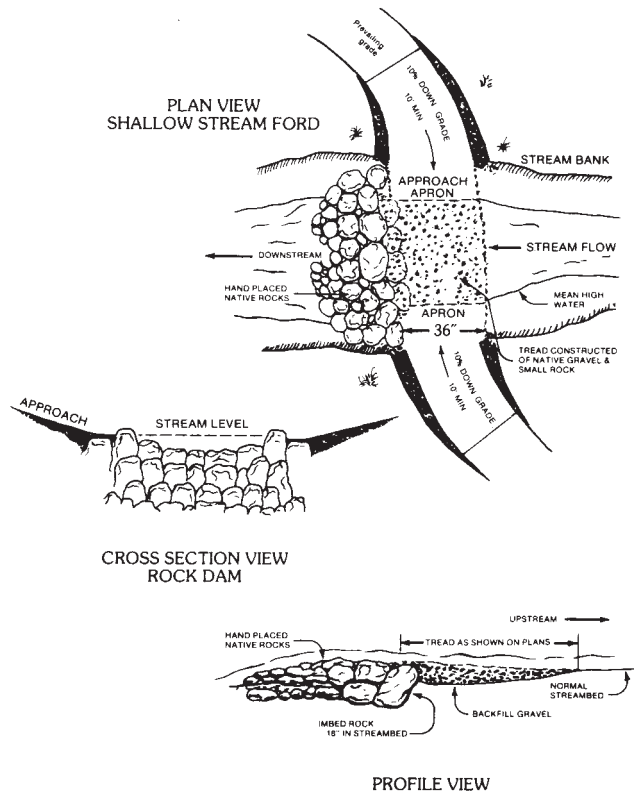

Build a small rock dam to create a shallow reservoir at the crossing point. On streams with a constant flow, place large stones (at least 16 inches in diameter) a minimum of 8 inches into the stream bed.

Fit smaller rocks between the large stones to form a solid wall. The top of the dam should be nearly even with the finished trail tread, serving as a shallow spillway.

Fill the stream bed in the reservoir itself with small stones and gravel.

On creeks with intermittent flows, the stones for the dam may be smaller in diameter (12 inches or larger), again planted about 8 inches into the stream bed. In this case, a log also may be used to form the dam. The log should be at least 8 inches in diameter and have its bark removed.

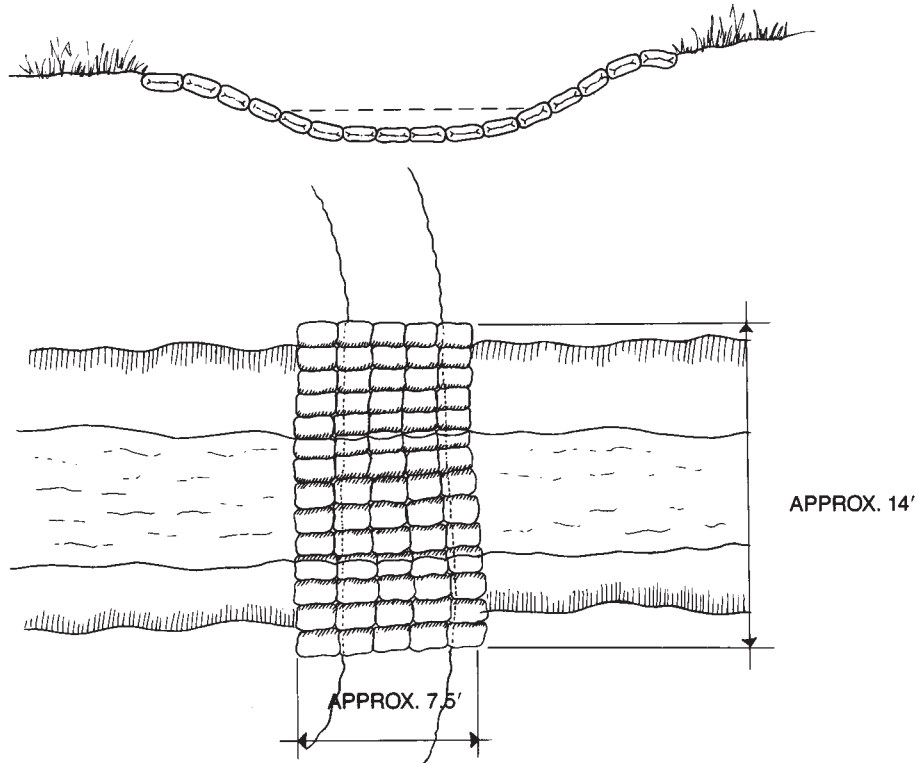

AN ALTERNATIVE STREAM FORD: PRE-MIX CONCRETE

Caution: This idea is not recommended for high velocity mountain streams.

On some properties, the use of stones and rocks for stream crossing is not plausible. The Talledega Ranger District of the National Forests in Alabama has successfully experimented with the placement of pre-mixed concrete to stabilize a crossing where frequent fast water foiled previous attempts to use culvert.

Construction In this solution, forest staff placed burlap bags of premixed concrete in five rows, with 16 bags per row. The bags were then laid side by side and end to end along the existing bed of the stream. The bags were then soaked in place.

No attempt was made to tie the bags together or to the stream bed. A light bond was formed by concrete seeping naturally out of each bag and mixing with the burlap and each other. By only having a light bond to tie each bag together, if one section of bags were to wash out in the future, the crossing could be repaired with minimal cost and effort.

The district reported several advantages from this crossing. It is readily adapted to different widths and lengths. No special equipment, tools or construction knowledge are required. Stream flow is left unobstructed. A firm base and a rough finish are provided for traction.

Finally, it was accomplished with minimal cost.

NEW AND ALTERNATIVE TECHNOLOGY

Although the subject of trail tread hardening draws much interest, very little research has been done using hardening techniques. Soil-cement apparently has been the most commonly tried technique of tread hardening. Those who have tried soil-cement express mixed results, although most report little success.

Pre-cast concrete blocks have been used on several National Forests for tread hardening. Others suggested the use of an **asphalt polymer** that has been used around picnic tables and on trails in the State of California. An article in the "Engineering Field Notes (October 1975; Volume 7, Number 10)" detailed the use of **fiberglass trail tread liners** installed through boggy areas on the Sierra National Forest. Follow up of that installation showed that the liners were unsuccessful and have been replaced. The October 1986 issue of WilderNews (a publication of the Moose Creek Ranger District on the Nez Perce National Forest) reported on a method of constructing foot and stock trail through wet areas. It consisted of excavating a three foot wide, one foot deep trench, lining it with **geofabric** and backfilling with sand and gravel.

A geotechnical/engineering product search turned up two additional potential methods of trail tread hardening. One is a plastic product marketed under the name of

Geoweb, a four or eight-inch thick plastic honeycomb grid confinement system. This was tried on the Wenatchee National Forest on a grade in excess of 20%. It was unsuccessful and removed after the second season of use. The other potential trail tread "hardener" is a **woven mat** made out of one to two inch strips of old tires. In 1991, a test section was installed on the Newport Ranger District on the Colville National Forest.

Using a grant funded by the Washington State Interagency Committee For Outdoor Recreation, the Wenatchee National Forest completed an evaluation in 1991 of four tread hardening techniques or products:

◆ **Soil-Cement:** Treatment of a trail tread consisted of mixing a calculated amount of Portland cement with native soils. This is **not recommended** for use on a trail with any kind of grade as the surface became very slippery with dust and vegetation litter such as tree needles.

◆ **Concrete blocks:** A pre-cast concrete block marketed under the name "**Grass Grid Paving Block**" made by Smithwick Block Company and Western Block Company of Portland, Oregon. These blocks are 17.25 inches wide X 23 inches long X 3.5 inches high with 4 X 4 inch holes. The blocks weigh about 60 pounds each and have a minimum compressive strength of 4000 psi. This technique is **recommended**.

◆ **Geoweb:** This is a grid confinement system made out of high density polyethylene. The manufacturer, Presto Products, Inc. of Appleton, Wisconsin, donated materials for use in this project. It comes either 4 or 8 inches thick and in sections 8 feet wide by 20 feet long (expanded). Collapsed, the sections are 11 feet 5 inches long by 4 or 8 inches thick. A 4-inch thick section weighs 57 pounds. This product is **not recommended where there is a grade**.

◆ **ECO-50 (asphalt polymer):** This is a polymerized asphalt product sold by Evergreen Chemical Products of Oakland, California for use as a soil solidifier on trails. It is applied to a trail scarified to the depth of treatment desired. This product **did not work in the evaluation**.

◆ An additional product being tested is **Three Directional Interlocking Cellular Concrete Mat:** These cellular concrete block are three directional interlocking components within a 16" equilateral triangular module and 4" high. They are marketed under the name TRI-LOCK and made by American Excelsior Company Arlington, Texas.

Wenatchee National Forest tried several other treatments. These have been installed but not formally evaluated and documented **as they did not have any initial favorable results:**



TRAIL CATTLEGUARD MATERIALS LIST

MATERIAL	QUANTITY	
	Order	Pre-Cut
BASE:		
2" x 12" treated std. & btr.	2 8' lengths 1 10' length	2 89" lengths 2 5' lengths
BRACE:		
2" x 10" treated std. & btr.	1 8' length	4 12" lengths
WINGS:		
2" x 4" treated std. & btr. with joist hangers or with wing supports	3 10' lengths 2 14' lengths 2 10' lengths 1 12' length 2 14' lengths	2 5', 2 10' lengths 4 7' lengths or 1 10', 2 5' lengths 1 10', 4 6' lengths 4 7' lengths
DECK:		
2" x 3" x 3/16" angle iron 2" x 2" x 3/16" square tubing rails	2 8' lengths 69' 6-3/4"	Precut and predrilled Precut and predrilled 14 59-5/8" lengths
HARDWARE:		
1/2" x 3" tempered steel hex head bolts (grade 5, coarse thread), washers, lock washers, nuts	29	
3/8" x 4" lag screws	7	
barbed or #9 wire	±12'	
16d galvanized common nails	2-1/2 lbs.	
1-1/2" galvanized fence staples	1/2 lb.	
6d galvanized common nails (for joist hangers)	1/2 lb.	
wood preservative meeting AWPA M4	1 gal.	
FURNISHED:		
posts and "H" braces		
OPTIONAL:		
Simpson SUR 26 skewed 45° joist hanger (or similar)	4	
Simpson SUL 26 skewed 45° joist hanger (or similar)	4	
paint		
reflectors and/or delineators		

NOTE: All lumber shall be pressure treated with creosote meeting AWPB LP 55 or water-borne preservatives meeting AWPB LP 22. Retention shall be 0.40 minimum.

◆ **Galvanized wire fencing:** This is a bad idea and should not be used. The wire fencing had a tendency to stretch and the surface would get washboardy. Eventually the wire broke and got tangled in the spokes and caused flat tires.

◆ **Cold mix asphalt:** Cold mix asphalt was used on a trail with grade in excess of 20%. The surface became very slippery from the dust and vegetation litter. Because the surface was too slippery for hiking or for stock and motorcycle use it was determined unsafe. The test section was relocated to reduce the grade and required the construction of a switchback.

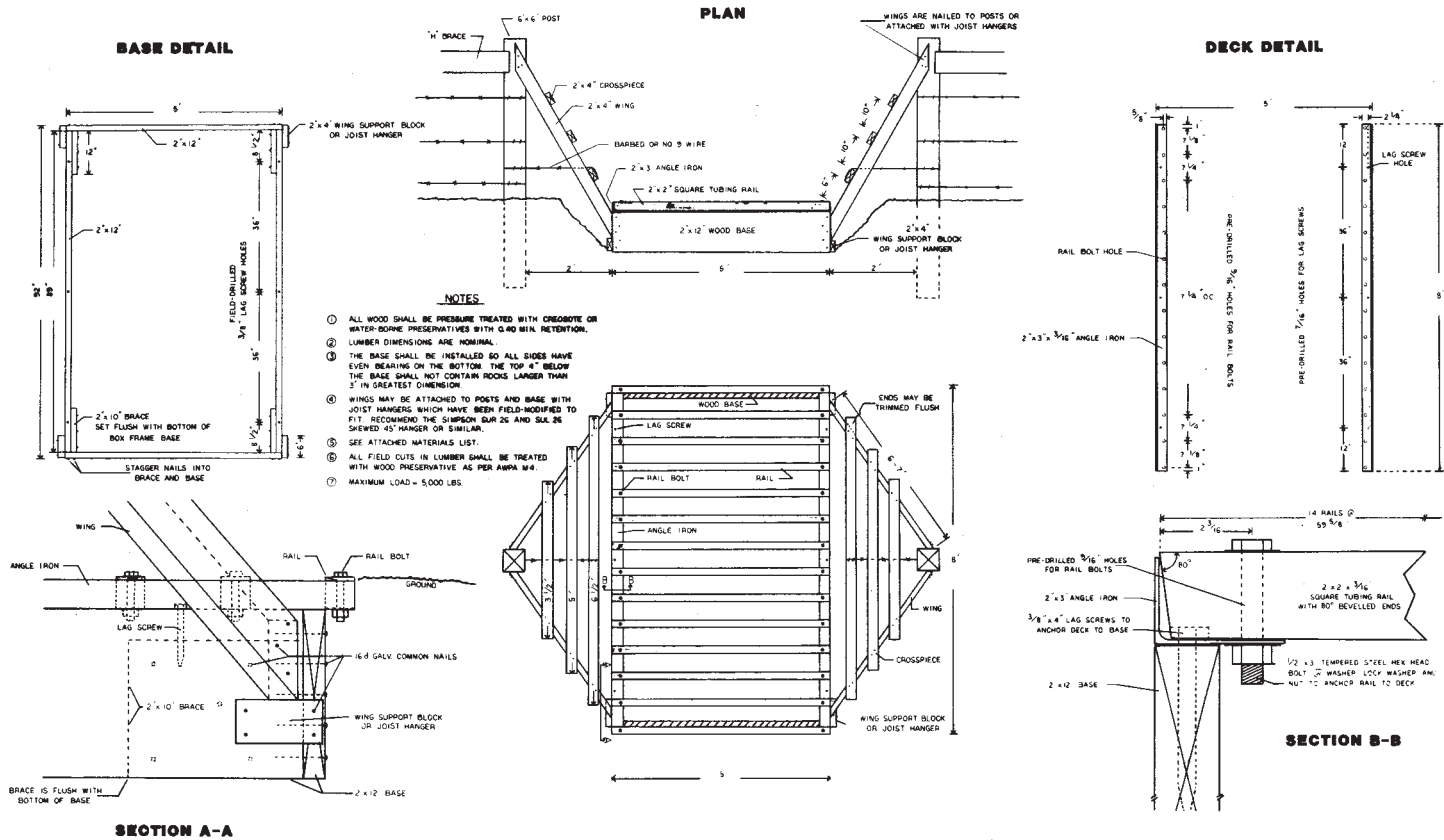

CATTLEGUARDS

Many of the properties used for wheeled recreation also have to accommodate other types of multiple uses. One of these uses is to graze cattle. The Fort Rock District of Deschutes National Forest has developed a trail cattleguard to accommodate recreational use while ensuring the integrity of grazing allotment fence lines. This was designed to be easily transportable and to be assembled on site. All materials are available at local lumber yards and machine shops. **IMPORTANT: All lumber should be treated with water-borne preservatives meeting AWPB LP 22. Retention shall be 0.40 minimum.**

Location

Locate the crossing so that the trail will cross at 90 degrees for safety. Where possible, locate the cattleguard in timbered or rocky areas to discourage access by full-

sized vehicles.

Construction This cattleguard is designed to be constructed using either regular staff or volunteers.

- ◆ First, set stakes to establish four corners and the grade.
- ◆ Have part of the crew excavate to accommodate the base at grade while others nail the box base together.
- ◆ Put the base in the hole. Compact the dirt under the base. The base must have firm, even bearing all around.
- ◆ Attach joist hangers (if used) before putting the base in the hole.
- ◆ Square up and level the base.
- ◆ Lay angle iron on the base. Put one rail on each end and loosely attach with bolts.
- ◆ Put on all other rails and put bolts through holes. Align the deck with the base, then tighten the bolts.

Install lag bolts.

- ◆ Construct the wings.
- ◆ Backfill the ends and smooth the approaches.
- ◆ Finally, install barbed wire from the bottom crosspiece to the posts.



This high quality finished trail provides enjoyable recreation with low maintenance costs.

A FINAL INSPECTION OF THE ENTIRE TRAIL

When construction is nearly complete, someone with expert knowledge of trailbike recreation and trail construction and management should make a final inspection. This individual should walk the trail on foot and ride the trail on a trailbike. Note and solve any problems before the construction crew leaves the site.

For about one year following completion of construction, monitor the trail for problems that need to be corrected. Problems may include soft spots that need additional fill, large rocks that protrude into the tread and wet spots that develop ruts. On most trails the back slope will tend to ravel for a period of time before it stabilizes. If too much material ravel onto the tread it will need to be removed. The trail manager should make plans (and budget accordingly) to accomplish this task while plans are made for construction.

Trails -- motorized and non-motorized alike -- are dynamic structures that continue to change throughout their useful life and well beyond. Planning and construction are accomplished in a short span of time.



A well-designed trail system will include a mix of Easiest (top), More Difficult (center) and Most Difficult (bottom) trails. This mix of trail difficulties provides recreation opportunities for riders of varying ability.



However, maintenance is an activity that continues throughout the life of the facility. If properly planned and constructed, maintenance will be minimized. It will never be eliminated. Competent, well-planned maintenance and management are the final key to successful trails!

SIGNAGE

Trail signage is an important element of all trail systems, necessary to provide users with information relating to trail identification, difficulty and regulations.

Trail signing should always include identification and information signs at trailheads, at trail intersections and on trails. In addition, signing can include interpretive information, distances to trail intersections, public facilities, access points, destinations and educational information encouraging responsible trail use. Signing can be very important for delineating private property boundaries. Accomplish all trail signing according to state or federal regulations when constructing trails on public lands.

Trail signing materials will vary according to state and federal requirements; however, all signs should be suitable for the climate conditions for the area, located to



Adequate signing is an important part of the trail system. Signing helps to notify riders of trail direction, distances, difficulty and other important information relating to the riding experience.

avoid creating a hazard for riders while remaining visible to OHV operators.

Trail signs should be rustic and unobtrusive. Avoid bright colors and synthetic materials where possible.

Proper trail signing can improve the recreational experience of OHV users by providing the necessary information to ensure that riders are aware of area regulations and trail conditions. A good signing plan helps riders comply with local regulations and makes law enforcement easier.

CHAPTER FIVE

SWITCHBACKS AND CLIMBING TURNS

Switchbacks and climbing turns are trail structures that require special consideration. They are widely used in all types of recreation trails. The importance of their design and the mitigation of damage when improperly designed requires highlighting in their own chapter.

Briefly, a switchback is a sharp turn of about 180 degrees. It is used to reverse direction or lessen the grade of trails on steep slopes. A climbing turn is similar, but the radius is larger. Use switchbacks only on motorized trails serving trailbikes. Climbing turns may be used on trailbike trails. However, when developing trails for use by all-terrain vehicles, use only climbing turns.

The manager should become familiar with both types of turns. The techniques for locating and constructing each are similar and are explained below.

DEVELOPING SWITCHBACKS

In mountainous terrain it is often necessary to use switchbacks to develop a viable trail route through areas of difficult construction, or to gain elevation in confined locations. Besides being a tool necessary for trail development, **properly constructed** switchbacks provide an interesting and enjoyable riding experience.

Be aware that incorrectly built switchbacks are difficult (or dangerous) to ride and expensive to maintain. Location, design and construction of switchbacks and climbing turns are difficult skills to master. This is one area where one may encounter incompetent work in trail development. To develop sound, workable structures requires careful design and a knowledge of both trails and trailbike riding.

Locate and design structures long before construction begins. Correcting a poor design will often require relocating and rebuilding a portion of the trail. Economics demand it be done right the first time.

Location

- ◆ The best location is a flat bench 8 to 20 feet wide; next best is terrain with the least slope. Steep ground is the most difficult and costly site to build switchbacks due to the heavy excavation required and the difficulty in obtaining an adequate radius and moderate grade. Be very careful in selecting switchback/climbing turn locations. It is preferable to pick locations where the trail will "switch" (turn) to the left when going downhill. Since virtually all trailbikes have their rear-wheel brake pedal on the right side, a switchback to the left allows the rider to put their left

foot on the ground for balance while keeping the right foot on the brake pedal.

- ◆ Study and analyze the location, visualize the completed trail, then design the entrance and exit layout for riders coming from both directions.
- ◆ Lay out the curve in a smooth, even radius.

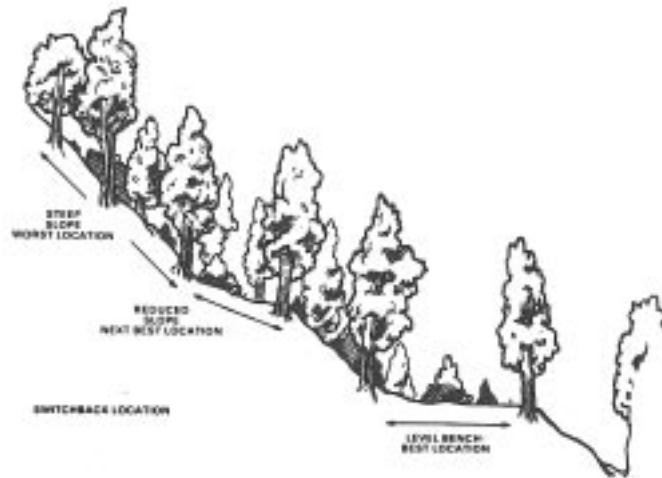
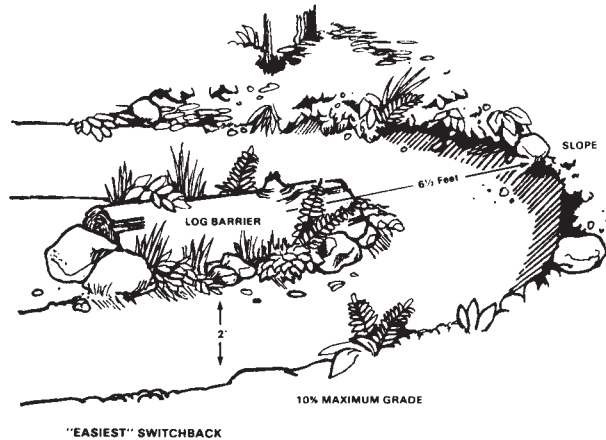

Design	Easiest		Most Difficult
Radius (not less than)	6 1/2	to	4 feet
Grade (not more than)	10%	to	25%
Tread Width	48	to	48 inches

SWITCHBACK DESIGN MINIMUMS

Switchback design is dictated by trail difficulty, steepness of prevailing ground, slope and width of bench and soil type.

- ◆ The physical layout of the switchback must consider rider skill level. Minimum dimensions vary considerably between Easiest and Most Difficult.
- ◆ The grade of the switchback should always be compatible with the type of soil on which it is built. At times it is necessary to use tread armor, however, from the point of view of recreationists, armor is not desirable on a switchback. If possible, avoid it. In some places, tread armor has been used as a crutch in place of competent design, a mistake that should be avoided.
- ◆ Use a barrier to prevent trail traffic from cross-cutting. The log barrier in the diagram is an inexpensive solution.
- ◆ **USE THE LOWEST GRADE FEASIBLE FROM 5 TO 10 FEET BEFORE THE TURN BEGINS TO 10 FEET BEYOND THE TURN.** Many potentially good quality switchbacks have been ruined by using grades that are unnecessarily steep. The steeper the grade of a switchback the more difficult it is to ride and the more expensive it is to maintain. **IT IS ABSOLUTELY CRITICAL THAT THE GRADE OF THE TRAIL THROUGH THE SWITCHBACK BE KEPT AS LOW AS POSSIBLE.**
- ◆ A key technique that can greatly improve the quality of almost any switchback is to use a "through cut." Locate the through cut from just beyond the midpoint of the curve to 5 feet beyond the UPHILL end of the turn (see diagram). The "through cut" performs two critical functions: it reduces the grade of the trail through the switch and it makes the trail through the switchback much easier and safer to ride.

Construction

- ◆ Thoroughly stake the location on the ground. It is suggested that a stake be placed every 4 feet on centerline. The stake should indicate cut or fill at centerline. The stake controls both grade and alignment.
- ◆ It is particularly important to obtain a smooth, even grade and a stable tread. If large rocks are encountered during excavation they should be removed. Place them in a shallow trench at the base of the fill to add stability and width to the trail.
- ◆ Where possible use native materials for trail tread and protection from cross-cutting.

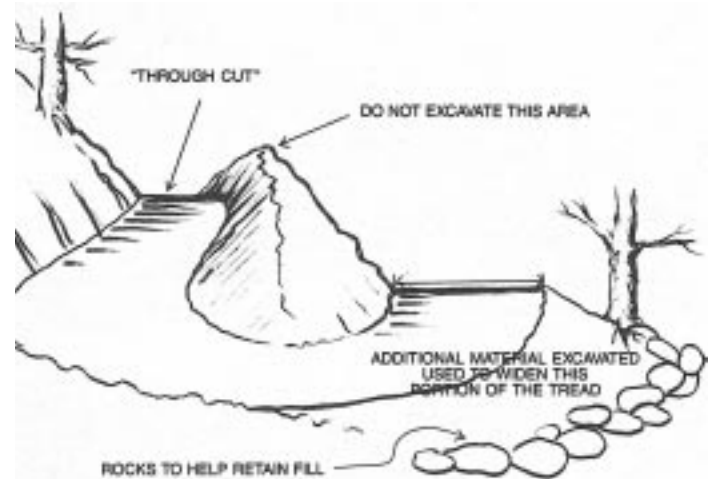

Two views of a switchback using a "through cut." The cross section above shows the unexcavated area, resulting in the through cut. Widen the lower portion with additional fill. Use rocks to help retain the fill. Below, the arrows point out where the trail should be widened with additional fill.

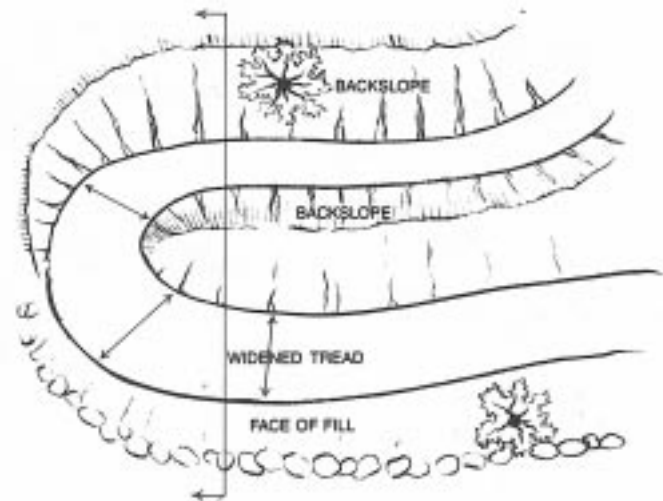

ARMORING SWITCHBACKS

At times trail managers may be faced with the problem of switchbacks that develop deep ruts. When this condition occurs, relocate the trail or implement a permanent repair that will prevent further trail surface degradation.

This book presents several methods for protecting trail tread. Unfortunately, none are entirely suitable for use on switchbacks. We, in fact, caution against using many of the tread protection devices unless trail alignment is very gentle and straight. Fortunately, a technique invented by a trailbike club in Washington has had some success in

repairing and armoring rutted switchbacks. Although successful on switchbacks with a gentle grade, many believe that the technique has been overused or seriously abused.

WARNING: If this technique is attempted on steep switchbacks, a situation creating serious and unnecessary harm to trail riders and possible equestrians may be created.

The procedure, like many good ideas, is relatively simple if used with discretion and limited to switchbacks of moderate grade. The maximum grade suitable to this type of tread armor varies with the site and turn radius. In

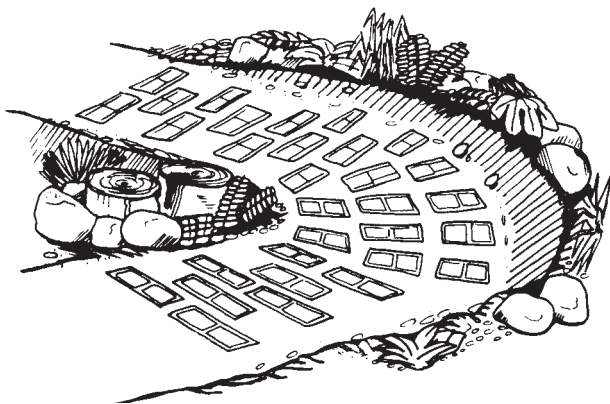

Occasionally, it is necessary to locate a switchback on unstable soils. To prevent soil loss, concrete blocks can be installed on the switchback. Be sure that proper construction techniques are followed.

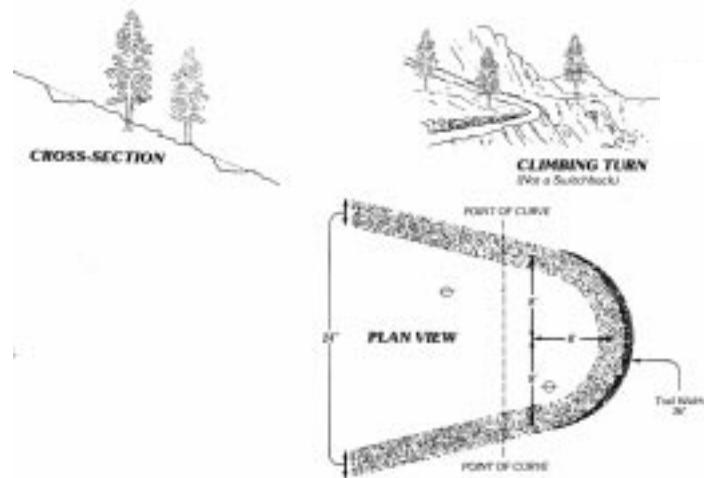

the writer's experience use should be limited to a maximum grade of 20%. The result is a switchback armored with concrete building blocks, grass block or interlocking paving stones (referred to as "armor") that is essentially impervious to rutting.

Before deciding to install armor, take time to make a thorough evaluation of the switchback and the trail leading to it. If the trail or switchback is improperly located or designed, then that problem ought to be corrected first. If the trail is new or if the switchback has been reconstructed, then accumulate several months of trailbike traffic before proceeding further.



This properly developed climbing turn is located on a gentle slope and maintains an effective barrier to prevent cross-cutting of the trail.

Normally a properly designed switchback does not require the use of armor. By accumulating some use, you may find that additional expense is unnecessary.

If, after making any needed changes in the trail, armor is still needed, then the next step is to excavate a trench 2 inches deeper than the height of the blocks you will use. The width of the trench should be just slightly greater than the tread -- usually 3 to 4 feet, wider for ATV trails. The bottom of the trench should be firm, smooth, even, and it should slope toward the inside of the curve, at about a half inch to 1 foot to give a "banked" effect.

CAUTION: Do not allow the trench or blocks to slope outward, as this situation can create a condition hazardous to riders.

Place armor open side up in the trench in a pattern similar to that shown in the drawings. The top of the blocks (which form the running surface) should slope toward the inside of the curve at a half inch to 1 foot -- the same as the bottom of the trench. Fill all voids, including holes in blocks with damp soil and compact. The soil used to fill voids should contain enough clay to act as a good "binder." It may be necessary to import material to mix with the resident soil.

As a follow up, monitor the installation, watch for loose blocks and for a sharp rut at the edge of the blocks. Determine if additional width is needed.

The most difficult part of the operation is transporting concrete blocks or other armor from the trailhead to the work site. One method that has worked well is to enlist

the volunteer help of an active trailbike or ATV club. In some areas mechanical toters have been used. Some agencies use ATV-towed trailers on appropriate ATV trails.

As with all tread protection devices, armor is not the answer to trails located improperly. It does, however, offer at least a partial solution on certain switchbacks. This technique has also been used on approaches to creek fords.

CLIMBING TURNS

As stated earlier, climbing turns should be used on ATV trails. Only the most skilled ATV rider can successfully negotiate sharp switchbacks and in doing so they may cause tread damage. The same rules of thumb should be followed for climbing turns as for switchbacks. Tread width and grade should be consistent throughout the turn. The construction techniques also apply. Remember to include some sort of barrier to discourage shortcuts.

For ATVs, tread width approaches should be 60 inches and the point of the turn should have an 8 foot to 10 foot radius with the tread width expanded to 72 inches. Allow the inside of the turn radius to be almost flat to accommodate the lower difficulty ratings. Have a berm or bank 24 inches high and insloped 30 to 45 degrees. It may be desirable to place rolling dips before and after the turn to eliminate water run off collecting in the turn. All facilities require mechanical compacting to take the extra weight and the spinning or skidding of ATV tires.

CHAPTER SIX

MONITORING AND ONGOING MANAGEMENT

Having a successful OHV plan requires that a monitoring and evaluation program be developed. Monitoring and evaluation each have a distinctly different purpose and scope. In general, monitoring is designed to gather the data necessary for evaluation. During evaluation, data provided through monitoring is analyzed and interpreted. This process will provide periodic summary data necessary to determine if your implementation is meeting the objectives of the OHV plan.

The manager should be prepared to ask a variety of questions: Are existing trails providing the variety of opportunities intended in the OHV plan? Is trail use occurring without impairment of other resource values? Are trails with mixed users (e.g. horse/OHV, mountain bike/OHV) meeting the expectations for all intended users? Is trail mileage adequate to provide quality OHV recreation? Does the OHV plan unfairly discriminate against OHV recreationists? If so, does the OHV plan need to be rewritten or just revised?

The manager should be able to know rather quickly if the trail system is on a threshold of viability. Are the miles of OHV trail constructed and maintained within 25% of the annual amount estimated in the OHV plan and within 10% for the decade? Are tread features stable? Do comments from the public indicate a decreasing trend in conflict among trail users?

Then there are the tough questions that are so hard to ask and so easy to ignore: Is it necessary to restrict non-motorized use to protect the quality of the motorized trail experience? Is logging or other management activity destroying or compromising the quality of the trail experience? What needs to be done to mitigate the impact of other activities on motorized recreation? Is there bias or prejudice against motorized recreation within the agency? Are motorized users unintentionally subjected to bias or prejudice?

Some of the information needed for monitoring and evaluation will already be available in the manager's office. These include reviews of project accomplishment reports, trail condition surveys and letters and other correspondence. The manager will have to go out and develop others such as field contacts and customer interviews. For public lands, annual open houses and

regular contact with organized clubs and groups with an interest in the area's management are also good tools.

THE LOCKWOOD INDICATOR SCALE

A report card, dubbed the Lockwood OHV Indicator Scale, by Cam Lockwood, OHV Program Coordinator for the Angeles National Forest, is a tool that may help you identify areas of deficiency in your OHV program.

The test is simple, for every item listed, there is a maximum total of either 5 or 10 points. Initially you may wish to rate yourself. Strive to be honest and objective, consider each item from the perspective of the motorized recreationist. Some may not be applicable to your area. For instance, the Angeles also manages for dune buggy and four-wheel-drive recreation. However, for the most part, the items listed are critical to providing a quality recreation experience.

INFORMATION:

- ◆ Quality trail maps (handouts), 0-5 points ____
- ◆ Signing (trail, trailhead), 0-5 points____
- ◆ Brochures (visitor information, public affairs), 0-5 points____
- ◆ Visitor centers, 0-5 points____

RESOURCES:

- ◆ Adequate trail riding opportunities (one and two days), 0-10 points____
- ◆ Varied terrain and levels of difficulty (for each type of vehicle), 0-5 points____
- ◆ Quality riding experience, 0-5 points____

FACILITIES:

- ◆ Trail mileage minimums (OHV:75/150, ATV: 45/100, dune buggy: 70/150, 4x4: 15/50), 0-5 points ____
- ◆ Trailhead facilities (surfaced parking, info kiosk, rock hopping, practice loops), 0-5 points____
- ◆ Staging area facilities (tot lots, mud bogs, hill climbs), 0-5 points____
- ◆ Campgrounds/visitor centers designed to accommodate OHVs, 0-5 points____

INVOLVEMENT:

- ◆ Local/regional groups (users and nonusers), 0-5 points _____
- ◆ Master performer use (interagency OHV experts), 0-5 points _____
- ◆ Volunteer patrol program (information), 0-5 points _____
- ◆ Law enforcement, 0-5 points _____

EVALUATION:

- ◆ Yearly meeting to discuss program (good or bad), 0-5 points _____
- ◆ Get the word out (newsletter info chain), 0-5 points _____
- ◆ Keep core groups involved and informed, 0-10 points _____

TOTAL _____

Scoring: 90-100 = A, Great!, 80-89 = B, Getting Better, 70-79 = C, Adequate, 60-69 = D, Bound to Fail, Below 60 = F, Not Making It.

If you have a "C" or worse, your performance may be substandard and you need to be concerned. Fortunately there are people in the field who want to and can help.

Ask Your Users! The way to obtain an objective evaluation of your performance is to ask OHV enthusiasts who use the area to fill out the scale and give you their honest opinion. Be prepared for them to score a bit differently than you would. It may well be that an evaluation by OHV users is the only one that is meaningful. As a follow up, spend some time with the OHV enthusiasts who frequent your area.

Go riding with them and share their campfires in an informal (i.e. off duty) capacity. Listen to what makes their day and what turns them off. Bring up the subject of what makes a really great riding area, listen to their responses and ask them why.

MASTER PERFORMERS

Region 6 of the Forest Service has developed a Travel-Way Master Performers program. The program allows Forests to tap skilled and experienced individuals in the areas of planning, design, development, contracting, and maintenance for recreation travel-ways.

Travel-Way Master Performers represent the Forest, and may spend about 10% to 15% of their time as a consultant to other Forests or organizations. They are responsible for identifying training opportunities, technology transfer, technical approval, and review of conceptual design of travel-ways, including safety, intended use, and cost.



Resource damage can occur on any kind of trail. This is a non-motorized trail.

THE DOUBLE STANDARD

Many OHV enthusiasts pursue other forms of trail based recreation. It is not all that unusual in the West to encounter a pickup truck with trailbike in the back pulling a trailer with saddle horses; others ride mountain bikes or even hike. This diversity of trail based pursuits brings OHV enthusiasts into contact with the management of non-motorized trails.

In the process, many members of the OHV community have discovered that some agencies apply standards to motorized trails that are not just different, but inequitable, hypocritical or downright dishonest. It is sometimes found that little concern is displayed for severely damaged trails in designated wilderness when the same trail would be closed if it were in an area open to motorized use.

The photograph shows a severely rutted trail, (the rut is close to 3 feet in depth) in a designated wilderness area, a trail that causes no apparent concern to the managing agency. Twenty miles away the same agency, citing "resource damage," has closed trails to motorized use with less than one tenth of the "damage." The reader is left to ponder whether an agency that behaves in this manner deserves or can expect to receive the esteem of OHV recreationists ... or anyone else.

TRAILS, ROADS AND TIMBER HARVEST

Anyone familiar with OHV recreation should be aware that unlike hiker and horse trails, OHV trails seldom have effective protection from damage or obliteration by management activities and other land uses.

An article in the April 1989 issue of Blue Ribbon Magazine entitled "Multiple Use Trail Crisis" addresses the subject of management-induced trail damage.

The article begins with a graphic description of a trail outing ruined by the destruction of a favorite trail. It goes on to say: "Unfortunately, trail disruption and destruction have reached epidemic proportions in many National Forests throughout the West." The article questions the wisdom of management decisions that result in damage to multiple use trails. "Is all of this trail destruction necessary?" The irony of it all is that trail destruction is so utterly unnecessary if forest supervisors would require harvest planners to make a reasonable effort to protect this precious resource.

There are a wide range of options available that make it entirely feasible to both provide the timber needed for our western economy and to ensure adequate protection of the trail systems that lace our national forests.

The article also suggests ways in which trail systems might be protected. "Harvest plans can avoid trails altogether. Green belts of wind firm timber can be left on both sides of the trail. Transportation systems can be configured to enhance harvest system design that protects trails. Timber purchasers can be prohibited from

yarding or skidding across trails. Landings can be located to enhance that type of protection or trails can be relocated into standing timber before logging and road building begins."

The cost of constructing a mile of new forest trail can vary from several hundred dollars to over \$30,000. The sense of personal loss experienced by individual OHV recreationists when a favorite trail is damaged or destroyed by poorly planned management activities virtually guarantees that the agency responsible will suffer loss of respect and loss of public confidence in their ability to do the job.

Management plans should be developed that ensure trail recreation and other activities are carefully integrated to protect the investment in trails and avoid eroding the quality of the trail experience. It must be pointed out that with the growing pressures of an increasingly urban society, the social value of a wildland trail experience is exponentially increasing.

Allowing other land use or management activities to damage or destroy the few trails available to the motorized recreation community can scarcely be considered competent management.

For those interested in the value placed on wildland trails by the trailbike community, the Blue Ribbon Coalition has published the "Blue Ribbon Coalition Acceptability Index For Timber Harvest Activities That May Impact Trailbike Trails." The index rates the acceptability of various timber harvest activities on trailbike trails.

CHAPTER SEVEN VOLUNTEERS

In times of constantly decreasing budgets for recreational programs, the need to identify alternative sources of assistance becomes quite real. Volunteers have been shown to be an excellent source of labor for trail construction, maintenance and management. This is especially true in national forests, where volunteers, through programs such as "Adopt-A-Trail," provide a significant amount of assistance in maintaining forest trails.

All volunteer assistance should be regulated by forest managers and should be documented in volunteer contract agreements similar to those utilized by the U.S. Forest Service.

Additionally, several federal land management agencies offer Challenge Cost-Share Agreements. These calculate a value for the time, labor, materials, equipment and dollars donated by organized volunteers. Extra agency funds are then made available on a matching basis (although there is a match, it is not necessarily on a 1-1 basis) to further develop the recreational opportunity.

Volunteers in an Adopt-A-Trail program can be expected to provide labor, tools and equipment that would be required to perform basic maintenance on forest trails. Such work might include removal of logs blocking trails, limbs encroaching on trails, rocks from trail tread and maintenance and replacement of simple trail structures.

All work must be monitored to ensure compliance with state or federal standards for those trails. Volunteers

or clubs involved in Adopt-A-Trail programs should perform at least one scheduled work day per season. Volunteers or clubs should provide forest managers with a complete list of all persons to be involved in work prior to start of work day.

Volunteers or clubs should provide necessary supervision and leadership for groups when work is being performed. Agency managers should provide trail maintenance standards, technical advice, guidance and inspection as may be necessary for the proper conduct of project work. Managers should furnish special project equipment or special tools as may be required for trail construction, maintenance or relocation. Managers should always provide appropriate signing indicating that the trail is maintained by volunteers through the Adopt-A-Trail program.

Volunteers should not expect reimbursement for incidental expenses, except when provided for under previously established agreements. Volunteers should be



Organized volunteer groups can play an important role in maintaining trails and other related facilities. Here, volunteers help to construct a trail staging area and campsite.



informed that most incidental expenses, such as travel associated with volunteer work, are tax deductible.

It is understood that any improvements constructed under Adopt-A-Trail programs remain the property of the managing agency and management of the "adopted" trail, including necessary seasonal closures, will remain the responsibility of the managing agency.

No special use privileges will be granted to volunteers



It is important that volunteers be organized and supervised by trained personnel.



Here, volunteers maintain a section of trail by clearing rocks and other material from the trail tread.

or club members in return for volunteer assistance. In appreciation for volunteer assistance, land managers

should be encouraged to provide some form of recognition (pin, patch, certificate) to volunteers and clubs.

Volunteer programs have a value that extends beyond the actual construction or maintenance activities because such programs also serve to promote goodwill and to develop a communication network between OHV operators and trail managers.

It is important not to burn out volunteers through undesirable tasks, overuse or over supervision. The knowledgeable manager will use volunteer programs as an opportunity to learn more about the recreation. Sometimes agency standards are inappropriate or completely improper. The wise manager asks questions, listens and learns to be flexible. Volunteers are a valuable resource - don't waste them!

Some guidelines for the effective and efficient use of volunteer labor are:

- ◆ Limit their involvement to 2-4 hours of work a day.
- ◆ Pick projects that will show tangible results when through.
- ◆ Make sure all the agency supervisors are ready to put the volunteers to work immediately upon arrival. Have tools readily available.
- ◆ Find out if you have people with particular talents and give them some responsibility.
- ◆ Recognize volunteers for their time and efforts. Look into agency award programs and programs run by other government offices.

Volunteer efforts should be recognized through other methods. Use press releases to local newspapers and other media. If your agency publishes a newsletter, submit a picture and article for publication. Media exposure will get your agency positive publicity, encourage other prospective volunteers and give your current volunteers a lift.

Sample volunteer agreements, cost-share agreements and press releases can be obtained by contacting the AMA.



CHAPTER EIGHT

NOISE MANAGEMENT AND SOUND TESTING

An important consideration in OHV trail design is the potential impact of sound on other recreationists and nearby homes. Excessive noise is the most commonly identified complaint relating to motorized recreation. If a trail or use area is established without assessing the sound impacts, it could have a short life span. Talking to other user groups and local community organizations can save much guesswork and trouble down the line.

NATURAL CONDITIONS

The OHV planner can do many things to mitigate known or potential problems related to sound. Capitalizing on existing natural conditions will often accomplish the task.

Terrain Natural topography can have a great deal to do with how sound propagates in a particular area. A noisy source in a hollow isn't as serious as one in the open. Where ever possible, locate trails on the back side of ridge lines, facing away from nearby homes or other noise sensitive areas. Dry washes provide excellent corridors for OHV trails because the stream banks serve as effective sound barriers.

Vegetation A hard, horizontal surface such as pavement does little to attenuate sound levels, even over long distances. Covering that distance with thick grass or shrubbery, however, can have a limited effect. A hedge or narrow stand of trees does little to reduce sound levels.

Atmospheric Conditions While there is some sound attenuation from air absorption, it depends greatly on temperature, humidity, and the frequency of the sound itself. It is significant mainly with high frequency noises, and only over considerable distances. The deep sound of a four-stroke engine may not be as offensive as its higher pitched two-stroke counterpart, but the four-stroke will be heard over a greater distance.

Temperature Temperature's effect on sound, while only slight, is noticeable mainly at night. A normal temperature gradient, where temperature decreases with height above the ground, tends to cause sound waves to bend upward (away from the listener). This results in a lower sound level perceived by the listener. This situation changes when there is a temperature inversion (temperature increases with height). Such inversions often

occur on clear nights. In this case, sound waves are bent downward toward the ground, and the increased attenuation doesn't occur. Depending on the situation, this may be a good reason to prohibit night time riding near noise sensitive areas.

Distance Without a doubt, the best way to attenuate sound is through distance. The greater the space between noise sources and receptors, the fewer problems are likely to arise. In general, sound levels decrease by about 6 decibels (dB(A)) for each doubling of distance. This would apply to sound measurements of a single vehicle or a group of machines in a concentrated area. For example, an 88 dB(A) noise source at 50 feet would be 82 dB(A) at 100 feet, 76 dB(A) at 200 feet, and so on.

ADDITIONAL MEASURES

After employing the natural conditions in an area, additional measures may be taken if necessary:

Walls & Berms Solid vertical surfaces, such as walls or earth berms can make good sound barriers. These may be particularly useful between a sound source and noise sensitive areas such as campgrounds. The barrier must be substantially higher than, and close to, the sound source to be effective. A 6-8 foot high berm would help attenuate (reduce) noise from most OHV sources.

Ingress & Egress Beginning and ending trails properly can avoid potential problems with other recreationists. For example, how OHVs are able to enter and leave a campground can play a key role in the success or failure of a multiple use campground. Locate the main trunk access to the trail system away from as many campsites as possible. Consider erecting earth berms on either side as noise attenuators. Post signs throughout the campground limiting speeds for all vehicles to 5 mph, and enforce it. Make it clear to all that their machines are required to have quiet mufflers and spark arresters. Fifty OHVs can ride virtually unnoticed in the back country, but one noisy machine in a campground will be a nuisance to everyone.

Some trails access small towns for fuel and other services. Where using neighborhood streets for ingress or egress, post speed limit signs and messages to encourage courteous behavior. A sign that simply reads

"Please ride slowly and quietly, people live here," will pay big dividends! In short, concentrate your noise control efforts in areas where they'll do the most good.

MIXED USES

OHV trails may be used by many other user groups. OHV users are generally easy to get along with and are happy to share trails. In areas of high use, however, it's a good idea to tell all users what to expect before they begin. If hikers know beforehand that they can expect to meet motorized users on a trail, their tolerance for the sound of an engine will generally be increased. Similarly, it helps equestrians to know if they might encounter vehicles. If an equestrian is riding an unusually noise-sensitive horse, he may elect to ride in a different area, or at least be ready and able to react appropriately if an encounter occurs. Post simple signs at all trail entrances with symbols of the various user types allowed on that trail.

Basic Meter Positioning

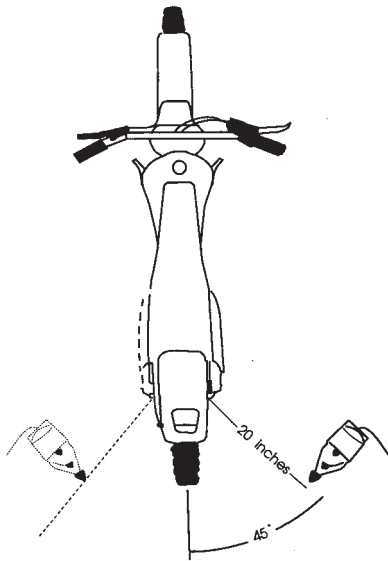

SOUND TESTING PROCEDURES

Off-highway motorcycle and ATV sound levels can be measured using stationary testing procedure SAE J1287, also known as the "20-inch test." It's a simple method of measuring exhaust sound emissions using readily available sound level meters. Basically, a machine is tested at one-half of its redline rpm, holding the meter 20 inches from the exhaust outlet.

The Motorcycle Industry Council (MIC) has published a substantial amount of information on the measurement and control of sound impacts. MIC annually publishes a pocket-sized manual illustrating how to perform the 20-

inch test. The booklet also contains data tables with test rpm's for at least a ten-year span of off-highway motorcycles and ATVs. The manual is designed for use by land managers, enforcement personnel, enthusiast organizations, and event sponsors.

For general off-highway use, MIC recommends a 20-inch limit of 96 dB(A) as the maximum allowable level for off-highway motorcycles and ATVs. Vehicles exceeding this limit should be considered inappropriate for use on public lands.

Ninety-nine dB(A) is currently the accepted maximum for OHVs on public lands managed by the federal government. However, several states have established lower limits. Land managers should learn the existing sound laws in their state.

Many states have codified some form of "pass-by" sound test. Although useful for automobile noise enforcement, these have little or no value for OHV enforcement work. In states without a 20-inch stationary regulation for OHVs, MIC suggests that the 96 dB(A) limit be used, even if only for educational purposes.

If you plan to implement a noise enforcement program based on the 20-inch test, contact the MIC and ask for a copy of the Stationary Sound Test Manual for Off-Highway Motorcycles and All-Terrain Vehicles. Single copies are available free to governmental agencies and OHV clubs.

EDUCATIONAL APPROACHES TO SOUND CONTROL

Without a formal noise statute, there are many things that the land manager can do to encourage awareness of noise impacts. From providing technical advice to conducting spot checks, riders can benefit from land managers who know a bit about sound.

Trailbikes and ATVs manufactured for general off-highway use come equipped with excellent mufflers and spark arresters. Short of a bad spill or owner modification, original equipment mufflers will perform adequately for many years.

Land managers will often encounter machines with mufflers using a repackable sound deadening material. These are original equipment mufflers on "motocross" motorcycles and on many after-market products. This type of exhaust system needs to be repacked after periods of use to keep exhaust noise to a reasonable level. Repacking is also necessary to retain peak engine performance.

Frequently, riders may not realize that their mufflers need to be repacked, or even be aware that they can repack them. Aside from being just plain noisy, a good clue that a muffler needs repacking is evidence of oil or heavy carbon accumulating at the exhaust outlet. This is usually a sign that the packing material has become so

saturated that it can no longer provide the sound damping needed. Conventional fiberglass insulation makes an excellent packing material and is readily available. Special repacking kits are also available from OHV dealers for many after-market mufflers.

OHV use areas with only a few entrance points provide excellent opportunities for random spot-checking. The best place to inform visitors of sound regulations or inspect vehicles for compliance is when they "come through the gates." Here, you have their undivided attention and a chance to convey important information.

Sound Testing at Organized Events

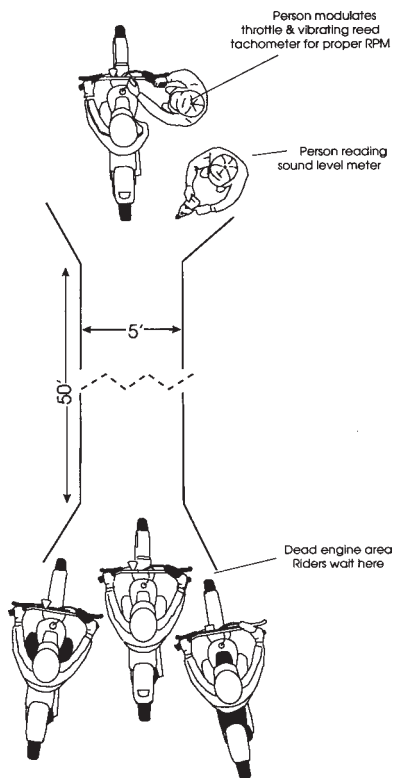

Sound testing at organized events (competitive and non-competitive) is a great way to spread the word about noise control. At an event like an enduro or hare scrambles, it's not uncommon to have 300-400 riders entered. Passing a simple sound check has become an accepted prerequisite for being allowed to ride an event. If set up properly, several hundred riders can be screened in a relatively short time.

The process is much easier if 2-3 people conduct the screening. You'll need a good quality sound level meter, a

vibrating reed tachometer (VRT), surveyor's flagging, and some wooden stakes. Set up the sound testing chute according to the diagram.

Test one rider at a time, with one person modulating the throttle to the correct engine speed, while the other person takes the sound level reading. Setting the VRT to each engine's exact test RPM would be too time consuming. Instead, pick an average test RPM and use it for all the machines entered in the event. For example, the Motorcycle Industry Council suggests 3400 RPM as an appropriate average for a typical enduro event.

Remember, this is just a screening process. If you intend to cite for non-compliance, or bar a rider from riding the event, use the model-specific test RPM from the MIC sound test manual.

After each rider has passed the sound check, affix a symbol, such as a non-transferable sticker, to their front number plate. This will tell race officials and land managers that the person has passed the sound test. If a rider doesn't pass the sound check, it's common practice to give the rider a chance to comply. Simply repacking the muffler (about a 15-minute job) will often yield a passing sound level. If an entrant then shows up at the starting line without evidence of a sound check, he should be denied the privilege of riding the event.

Many Forest Service and Bureau of Land Management jurisdictions have been using this simple screening method for years. Often, in their permit stipulations, the club or organization putting on the event is required to provide sound testing. Most off-highway event sponsors are familiar with the procedure and are happy to comply with this stipulation. If, however, the event is held in an unusually noise-sensitive area, it is recommended that the hosting agency perform the sound testing.

In time, a land manager will develop an "ear" for varying sound levels. Many OHV law enforcement personnel in the field have a "highly calibrated ear." They frequently know what a sound level reading will be before implementing the test!

When laying out a course for an event, take care to route it away from noise sensitive areas. Neighborhoods or areas normally not bothered by occasional recreational riders may experience noticeable impacts during an event with a large number of riders. If this is impractical, consider placing a limit on the number of entrants.

In any case, if the event is in proximity to a noise sensitive area, place limits on event hours. Sound considered tolerable during daylight hours may well be considered "noise" in the early morning or at dusk. Because motorcycles and ATVs tend to radiate exhaust sound rearward, consider routing sections where hard

acceleration occurs so that exhaust noise is aimed away from noise sensitive areas.

Motocross-Type Muffler (No Spark Arrester)

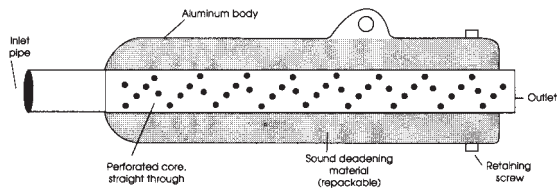

Original Equipment Muffler/Spark Arrester

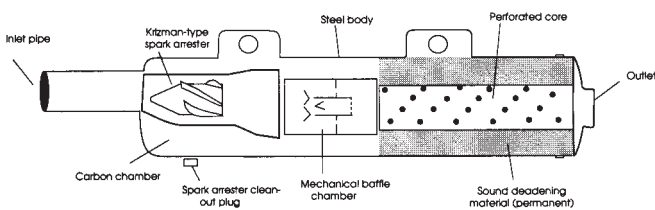

SPARK ARRESTERS

A spark arrester is a device which traps or pulverizes (to a size below .023-inch diameter) exhaust particles as they are expelled from an exhaust system. Most spark arresters perform in the high 90 percent spark arresting efficiency range.

Aftermarket Muffler/Spark Arrester

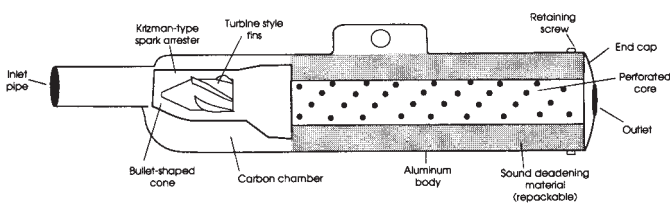

Spark arrester cleaned by removing spark arrester module through rear of muffler.

Aftermarket Muffler/Spark Arrester

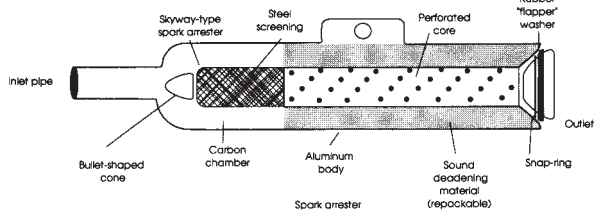

Spark arrester cleaned by removing spark arrester module through rear of muffler.

All trailbikes and ATVs manufactured for use on public lands come equipped with Forest Service qualified spark arresters. These are the same machines that meet strict federal noise regulations. "Racing Only" or motocross motorcycles are not so equipped at the factory, but may be fitted with after-market equipment to meet regulations.

To be legal for use on public lands, a spark arrester must be tested and approved by the Forest Service and listed in the official USDA Forest Service Spark Arrester

Aftermarket Muffler/Spark Arrester

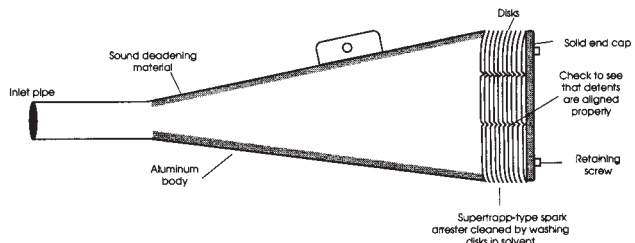

Guide. If it's not in the Guide, it's not a spark arrester! The vast majority of OHV spark arresters fall into three basic categories: Krizman, Skyway and Supertrapp. All three are patent names.

The Krizman and Skyway designs can be given a cursory check by inserting a 3/8" wooden dowel in the end of the exhaust outlet. If the spark arrester is intact, the dowel should stop a short distance into the muffler. If the dowel penetrates all the way through the muffler body and into the smaller diameter pipe immediately before it, the spark arrester is non-functional. A thin wire or coat hanger is not recommended for this test, as these can often be forced around the turbine fins used in the Krizman design or damage the screens in a Skyway type.

The Supertrapp design consists of a series of metal discs stacked on top of one another at the very end of the exhaust outlet. This design relies on the gap size between the discs for its spark arresting capability. When assembled properly, the gaps between the discs are small enough to prevent large carbon particles from exiting the exhaust system. To check this particular design, ensure that the small indents in the discs are all aligned properly. If they aren't, the gap between the discs will be enlarged and the spark arresting capacity nullified. Also, be sure there isn't a hole in the endpiece.

All three of these designs are incorporated into muffler/spark arrester combinations, or are available as "add-on" spark arrester only units. The add-ons clamp onto the end of an existing non-spark arrested muffler, typically found on motocross-type machines.

OHV NOISE & WILDLIFE

Over the years there has been much speculation as to the impacts of noise on wildlife. Studies of effects of human intrusion on animals often find profound impacts. As a result, it is commonly assumed that the impacts of OHV noise are equally as damaging. Research has shown that, while noise is initially startling, animals generally adapt very well under most circumstances. Long term effects to animals, particularly big game animals, are negligible. Much of the same research has shown that animals are more frightened by humans on foot than they are by OHVs.

A study commissioned by the Federal Highway Administration and performed by the U.S. Forest Service (Ward, Cupal, et al, 1976) near Laramie, Wyoming, found that elk were likely to remain lying down and unconcerned when a trailbike rode by as close as 15 yards. Conversely, the elk took flight virtually every time a human walked within 20-100 yards.

Another study commissioned by the California Department of Parks & Recreation (Jones & Stokes Associates, Inc. 1991) found similar results. No significant variation was found in the activity and foraging patterns of mule deer due to differing levels of OHV use.

Research commissioned by the Maine Department of Parks & Recreation (Anderson & Mason, Unity College, 1991) found that ATV use in Mt. Blue State Park had no significant effect on wildlife. Control areas were set up to compare ATV and non-ATV disturbances for several animal groups, including deer and birds.

Historically, it appears that wildlife disturbances attributed to OHV use have been overstated. Unusually high levels of OHV use, however, may have an effect on certain sensitive species, especially during reproductive stages. Where this occurs, short term seasonal closure may be a practical solution.

GLOSSARY

ABNEY An instrument used to measure angles of elevation.

ADOPT-A-TRAIL A program begun by the U.S. Forest Service in which trailriding clubs "adopt" motorcycle trails, providing volunteer work parties at periodic intervals. Though no special riding privileges are granted to the club, the agency generally acknowledges that a trail has been "adopted" by erecting signs saying the trail is part of the Adopt-A-Trail program.

ALIGNMENT The configuration of the trail in a horizontal plane. That is to say, the bends, curves and tangents of the path. The more crooked the route the more effort and skill it takes to ride. A crooked, twisting trail is usually preferred.

ALTIMETER An instrument for measuring altitude.

ANEROID BAROMETER A barometer in which changes in atmospheric pressure are used to measure changes in altitude.

ASPECT The particular direction a site faces and the amount of solar radiation it is subjected to.

ATV All-terrain vehicle. A small, three or four-wheeled vehicle equipped with low-pressure balloon tires and intended for off-highway use only.

BACKSLOPE The angle of the back wall of a trail excavated into a hillside.

CENTERING Constructing a trail in a manner which encourages traffic to use the center portion of the trail.

CLEARING The corridor from which vegetation is cleared. Within limits, wider clearing provides for easier travel.

CLIMBING TURN A turn of less than 180 degrees located on an up or downhill portion of a trail. See SWITCHBACK.

CLINOMETER An instrument used to measure angles of elevation.

COLLECTOR DITCH A drainage structure which intercepts water flowing toward a trail and channels it underneath the trail through a culvert.

CONTROL POINT An object or obstacle a trail must intersect with or avoid.

DECKING The portion of a bridge, puncheon or corduroy upon which trail traffic will travel.

DEFLECTION ANGLE The angle of deviation from a straight line.

DRAIN DIP An erosion-control technique which reverses the grade of a trail for a distance of 15-20 feet before returning to the prevailing grade. The abrupt change in grade forces water to run off the trail surface, rather than gaining additional velocity and volume.

ENGINEER'S SCALE A triangular rule which shows inches divided into tenths, useful for mapping when estimating mileage in tenths.

EXPOSURE The relative hazard encountered on a particular trail. Degree of exposure derives from the magnitude of one, or more frequently a combination of alignment, grade, clearing, tread width, tread surface, sideslope, obstacles and isolation.

FLAGLINE A series of strips of surveyor's tape indicating the intended course of a trail prior to construction.

FROE A cleaving tool used for splitting decking.

FULL BENCH A trail resting entirely on an excavation into a steep sideslope; no fill is used to support the trail.

GEOGRAPHIC INFORMATION SYSTEM A data base currently under development both nationally and for local public lands offices. Eventually, the system is to contain location data for trails, species habitat and other important features.

GLOBAL POSITIONING SYSTEM A system developed by the military, but now coming into widespread use by civilian agencies, to map road and trail locations using orbital satellites and portable equipment. Data gathered can be placed directly into GIS data base systems.

GRADE The slope of the trail in the direction of travel. The steeper the grade the more difficult the trail is to ride.

GRUBBING Digging out roots and stumps.

INSLOPE Slopes toward the inside of the trail.

ISOLATION The distance from help or human contact.

LOOP CONCEPT The practice of designing trail systems so that the routes form loops, giving trailriders the ability not to cover the same portions of trail in a day of riding.

MECHANICAL TOWER A piece of mechanized trail-construction equipment used for hauling rocks and other material.

OBSTACLES Physical objects large enough to significantly impede travel. Logs, large rocks and rock ledges are common obstacles.

OHV or ORV Off-highway or off-road vehicle. A motorized vehicle intended only for use off paved roads. Vehicles do not generally meet federal equipment and emissions standards, but do have to comply with special noise standards. Term often used to include motorcycles, three and four-wheeled all-terrain vehicles, four-wheel-drives and dune buggies. The term OHV is preferred.

OUTSLOPE Slopes toward the outside of the trail.

PITCH An increase in the prevailing grade of a trail, used to avoid an obstacle or to "catch up" with the intended grade.

POSITIVE GRADE Trail runs uphill.

PRISM The trail cross-section as a whole.

PUNCHEON A trail tread reinforcement structure resembling a low bridge and constructed over wet or otherwise unstable soil.

RAVELING Breaking up or crumbling and rolling downslope.

ROCK BALLAST Crushed rock fill material used to form the trail bed.

ROLL A decrease in the prevailing grade of a trail, allowing the trail to be routed under an obstacle or meet a control point.

SIDESLOPE The slope of the ground at its extreme angle, usually perpendicular to the direction of travel. As the magnitude of the sideslope increases so does the perception of difficulty and exposure.

SILL A horizontal member which rests on the ground and supports stringers in puncheon.

SLACK Increasing the prevailing grade of a climbing trail by several percent during layout. Permits planners to return to original grade to avoid obstacles.

STEREOSCOPE An optical instrument which allows a viewer to combine the images of two aerial photographs to give a three-dimensional effect.

STRINGER Poles or logs used to support decking in puncheon, corduroy and bridges.

SURVEY STAKE Stake used to indicate the intended course of a trail.

SWITCHBACK A sharp hillside turn, usually of about 180 degrees, intended to lessen the grade of a trail traveling up or down a steep slope.

TRAIL BED The portion of trail consisting of the trail tread and the soil underneath and around it.

TRAILBIKE A motorcycle constructed primarily for off-highway use, though some may be used legally on highways as well as on trails. The street-legal type is known as a dual-sport motorcycle. Trailbikes can be distinguished by their high-mounted fenders and exhaust system and tires with aggressive tread.

TRAIL HEAD The beginning of a trail system, often containing a campground and staging area.

TRAIL TREAD The portion of a trail on which trailbikes actually travel. Generally the same as TREAD SURFACE.

TRAVELWAY The trail as a whole, including the trail tread and the cleared areas on either side of the trail.

TREAD SURFACE The physical condition of the traveled portion of the trail. A tread becomes more difficult to ride as it becomes loose, rough, slippery, etc.

TREAD WIDTH The width of the "traveled" portion of the trail. Wider tread provides for easier travel.

TURNPIKE A tread-reinforcement technique used for crossing damp soil. Consists of poles placed parallel to each other with trail tread built up between them.

U.S.G.S. CONTOUR MAP Maps published by the United States Geological Survey, indicating manmade and

natural features as well as elevation changes. Available from many government offices, sporting goods stores or directly from the U.S.G.S. Branch of Distribution, 1200 S. Eads Street, Arlington, VA 22202.

WATERBAR Low rock or log barriers that divert water from the trail tread.

WATERCOURSE A natural or manmade channel through which water flows.

WHEEL GUARD Small logs or poles placed along the edges of bridge or puncheon decking designed to help keep vehicles from running off the edge of the structure.

RESOURCES

EQUIPMENT AND MATERIALS

The following are the addresses for some suppliers of equipment and materials useful in developing recreational trails. This is not an all-encompassing list. We encourage you to develop your own sources of supply. If you find an especially helpful source, please inform AMA so that we might include them in future editions.

Trail Building Machines

Kubota Tractor Corporation

440 W. Artesia Blvd.
Compton, CA 90220

Roberts Equipment, Inc.

P.O. Box 20463
Portland, OR 97220

Sutter Equipment Co.

SWECO Products, Inc.
80 Chamberlain Ave.

Novato, CA 94947

Takeuchi Mfg. LTD

Northeast Atlanta Industrial Park
4300-E. Bankers Circle

Atlanta, GA 30360

Trail Service Co.

6356 Whaley Drive
San Jose, CA 95135

or

15979 Cutler Road
Portland, MI 48875

Wilwand's

Box 183
Laytonville, CA 95454

Auxiliary Machinery and Equipment

Aircut

2588 S. Railroad Avenue
Fresno, CA 93706

Ariens

655 W. Ryan Street
Brillion, WI 54110

Berema, Inc.

10 Fifth Street
Norwalk, CT 06856

Chikusui Co., LTD

Franksons, Inc., Dist.
1004 S. Glendale Avenue
Glendale, CA 91205

Fuerst Brothers, Inc.

P.O. Box 427
Gibson City, IL 60936-0427

Interlocking Paving Stones

Muller Supply Co.

424 S. Main Street
Lodi, CA 95240

Recreational Trail Signs

Carsonite International

1301 Hot Springs Road
Carson City, NV 89706

J. L. Darling Corp.

2212 Port of Tacoma Road
Tacoma, WA 98421

BIBLIOGRAPHY

AMA 's Trail Riding in America; A Guide to Recreational Off-Road Riding. American Motorcyclist Association, Pickerington, OH, 1982 (out of print).

Bennett, Shaun. A Trail Rider's Guide to the Environment.

American Motorcyclist Association, Pickerington, OH, 1973 (out of print).

Birchard, William Jr., and Proudman, Robert. Trail Design, Construction, and Maintenance. The Appalachian Trail Conference, Harpers Ferry, WV, 1981.

Chilman, K.C., Vogel, J.J., and Conley, J.L. Turkey Bay Off-Road Vehicle Area at Land Between the Lakes: Monitoring Use and Impacts Since 1973, 1991.

Chilman, K.C. and Zeaman, W.S. Off-Road Vehicle Area Users at Five Designated Riding Areas Near Lake Tahoe: Designing a Use Monitoring System., USDA Forest Service, California Off-Highway Motor Vehicle Recreation Commission, 1992.

Facts About Trail Riders. American Motorcyclist Association, Pickerington, OH 1983 (out of print).

Hamilton, Nora. Tractor Techniques for OHV Trailbed Preservation on National Forest OHV Trails, Mendocino National Forest monograph, 1991.

Harrison, Robin T. Predicting Impacts of Noise on Recreationists, USDA Forest Service, 1980.

Jones and Stokes and Associates, Inc. Rock Creek Off-Road Vehicle Deer Study, USDA Forest Service, Eldorado National Forest, California Department of Fish

and Game and California Department of Parks and Recreation, 1991.

Gusey, Daryl L. Trail Hardening Test, Project #ORV-86-3P, Wenatchee National Forest, 1991.

Makel, Bill. Trail Bikes and All-Terrain Vehicles in the National Forest, A Management Approach, USDA Forest Service, 1988.

McEwen, Douglas. Turkey Bay Off-Road Vehicle Area at Land Between The Lakes: An Example of New Opportunities for Managers and Riders. Southern Illinois University, Carbondale, IL, 1978.

Motorcycle Statistical Annual, Motorcycle Industry Council, published annually.

Nash, A.E. Kier. Understanding and Planning for ORV Recreation. State of Washington, Olympia, WA, 1982.

Off-Highway Motorcycle and ATV Stationary Sound Test Manual, Motorcycle Industry Council, regularly revised.

Off-Road-Vehicle and Travel Management Activity Review, USDA Forest Service, 1986.

Planning for Trailbike Recreation. United States Department of Interior, Washington, DC, 1978.

Planning for Trailbike Recreation, Part II. United States Department of Interior, Washington, DC, 1980.

Rasor, Robert. Five State Approaches to Trailbike Recreation Facilities and Their Management. American Motorcyclist Association, Pickerington, OH, 1977.

Reed, Patrick and Haas, Glenn. Off-Highway Vehicles in Colorado (economic tourism impacts), Colorado State University, 1989.

Symmes, Dan. Taylor Fork ATV Trail System, USDA Forest Service, 1988.

Sound Levels of Five Motorcycles Traveling Over Forest Trails, USDA Forest Service, 1993.

Surface Water Control Techniques For Trail Maintenance (VHS Video), USDA Forest Service, 1992.

Tolhurst, Neil. Trail Riding: Skills, Safety and Sensibility. American Motorcyclist Association, Pickerington, OH, 1982.

Utah OHV Survey, Utah Division of Parks and Recreation(economic tourism impacts), 1990.

Van Der Smissen, Betty, J.D. Recreational User Statutes; A Review of Landowner Hold-Harmless Laws in the United States, American Motorcyclist Association, Pickerington, OH, 1988.

Wernex, Joseph. Development Guidelines for Trailbike Trails. Washington State Department of Natural Resources, Olympia, WA, 1976.

Wernex, Joseph. State ORV Planning and Management of Resources. Unpublished paper presented at Pacific Northwest Trailbike Workshop Olympia, WA, 1978.

Wernex, Joseph. Trailbike Trails. Unpublished paper presented at Sixth National Trails Symposium, University of California at Davis, CA, 1981.

Wernex, Joseph. Trails for Trailbikes. Unpublished paper

presented at Tahoe National Forest Off-Highway Motorcycle Workshop, Auburn, CA, 1983.

Wernex, Joseph. "Trail Tips." Articles written for publication in Motorcycle Industry Council newsletter.

Wright, Brett. A report on Strategies to Increase Public Recreational Access to Private Lands, 1990.

ADDITIONAL RESOURCES

American Motorcyclist Association

13515 Yarmouth Drive
Pickerington, OH 43147
(614) 856-1900
Fax: (614) 856-1920
www.AMADirectLink.com

A national non-profit association representing the interests of over 270,000 motorcycle and ATV enthusiasts. Founded in 1924, the purpose of the association is to "preserve, promote and protect" the rights of motorcyclists.

Blue Ribbon Coalition

P.O. Box 5449
Pocatello, ID 83202-0003
(800) 258-3742
www.sharetrails.org

A national multiple-use activist organization.

Motorcycle Industry Council

2 Jenner Street
Suite 150
Irvine, CA 92618-3806
(949) 727-4211
Fax (949) 727-3313
www.mic.org

A national, non-profit trade association representing the manufacturers of motorcycles, parts and accessories and allied trades.

National Off-Highway Vehicle Conservation Council

4718 South Taylor Drive
Sheboygan, WI 53081
(800) 348-6487
Fax: (920) 458-3446
www.nohvcc.org

A national network of state, regional and national OHV enthusiast organizations.

Tread Lightly! Inc.

298 24th Street
Suite 325
Ogden, UT 84401
(800) 966-9900
Fax: (801) 621-8633
www.treadlightly.org

A national non-profit organization dedicated to protecting public and private lands through education.

Specialty Vehicle Institute of America

2 Jenner Street
Suite 150
Irvine, CA 92618-3806
(949) 727-3727
www.atvsafety.org

A national, non-profit trade association representing the manufacturers of all-terrain vehicles, parts and accessories and allied trades.